

Cilindri tondi Serie 27

Doppio effetto, magnetici
 ø 20, 25, 32, 40, 50, 63 mm

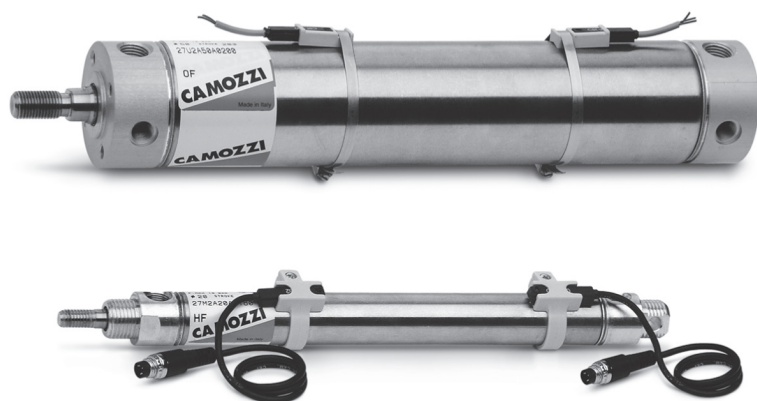

- » Ingombri ridotti
- » Versatilità nei fissaggi
- » Perfetta linearità dovuta alla bordatura

I cilindri Serie 27, costruiti con una linea estremamente pulita, sono stati realizzati cercando di ridurre al minimo gli ingombri. Camicia e stelo sono in acciaio Inox, mentre le testate sono in Alluminio.

Le soluzioni tecniche adottate e la scelta adeguata dei materiali ci hanno permesso di predisporre una serie di cilindri versatile e molto affidabile. Il particolare sistema di unione (bordatura) tra camicia e testata, infatti, assicura la perfetta linearità di tutti i particolari. Per rendere meno rumoroso l'impatto del pistone sulla testata, questi cilindri sono inoltre dotati di ammortizzatore meccanico. La Serie 27 è predisposta per il montaggio di sensori magnetici. Gli accessori di corredo ne consentono svariati fissaggi.

CARATTERISTICHE GENERALI

Tipo di costruzione	bordato
Funzionamento	doppio effetto
Materiali	testate = AL - stelo e camicia = INOX - pistone = AL guarnizioni pistone e stelo = PU
Tipo di fissaggio	pedini - controcerniera - ghiera - perni
Corse min-max	tutti i diametri 10 - 1000 mm
Alesaggi	ø 20, 25, 32, 40, 50, 63
Temperatura d'esercizio	0°C + 80°C (con aria secca - 20°C)
Pressione d'esercizio	1 + 10 bar
Velocità	10 + 1000 mm/sec (senza carico)
Fluido	aria filtrata, senza lubrificazione. Nel caso si utilizzasse aria lubrificata, si consiglia olio ISOVG32 e di non interrompere mai la lubrificazione.

TABELLA CORSE STANDARD PER CILINDRI A DOPPIO EFFETTO SERIE 27

Mod. 27M E 27T (ø 20 ÷ 40) e Mod. 27U (ø 20 ÷ 63)

CORSE STANDARD

Ø	10	25	40	50	80	100	125	160	200	250	300	320	400	500
20	▪	▪	▪	▪	▪	▪	▪	▪	▪	▪	▪	▪	▪	▪
25	▪	▪	▪	▪	▪	▪	▪	▪	▪	▪	▪	▪	▪	▪
32	▪	▪	▪	▪	▪	▪	▪	▪	▪	▪	▪	▪	▪	▪
40	▪	▪	▪	▪	▪	▪	▪	▪	▪	▪	▪	▪	▪	▪
50	▪	▪	▪	▪	▪	▪	▪	▪	▪	▪	▪	▪	▪	▪
63	▪	▪	▪	▪	▪	▪	▪	▪	▪	▪	▪	▪	▪	▪

ESEMPIO DI CODIFICA

27	M	2	A	20	A	0050
-----------	----------	----------	----------	-----------	----------	-------------

27	SERIE	
M	VERSIONE M = testata posteriore con ancoraggio a cerniera per ø 20-25-32-40 T = testata posteriore con connessione assiale per ø 20-25-32-40 U = testata posteriore con connessione radiale per ø 20-25-32-40-50-63	
2	FUNZIONAMENTO 2 = doppio effetto	SIMBOLO PNEUMATICO CD08
A	CARATTERISTICHE MATERIALI A = stelo INOX rullato - camicia INOX	
20	ALESAGGIO 20 = 20 mm - 25 = 25 mm - 32 = 32 mm - 40 = 40 mm - 50 = 50 mm - 63 = 63 mm	
A	TIPO COSTRUTTIVO A = standard	
0050	CORSA (vedi tabella)	

SIMBOLI PNEUMATICI

I simboli pneumatici indicati nell'ESEMPIO DI CODIFICA sono riportati di seguito.



CD08

ACCESSORI CILINDRI SERIE 27
1

MOVIMENTO

 Giunto compensatore
Mod. GKF

 Snodo autoallineante
Mod. GK

 Ancoraggio a perno
Mod. T

 Snodo sferico maschio
Mod. GY

Snodo sferico Mod. GA



 Ancoraggio a piedini
Mod. B

 Ancoraggio a piedini
Mod. B

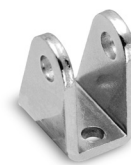

Ghiera Mod. V

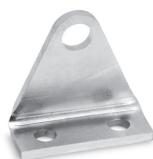
 Ancoraggio a controcerniera
Mod. I

Dado stelo Mod. U

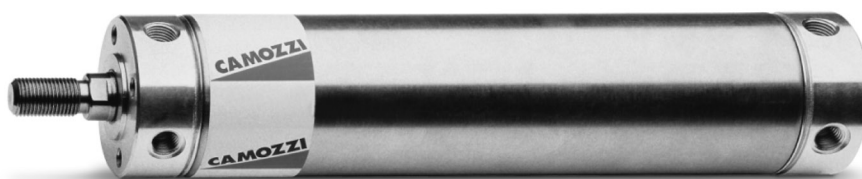

 Ancoraggio a controcerniera
Mod. I

Forcella Mod. G

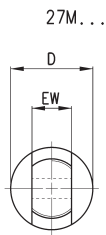

Tutti gli accessori sono forniti separatamente al cilindro.

Cilindri Serie 27 (Ø 20, 25, 32, 40)



+ = sommare la corsa

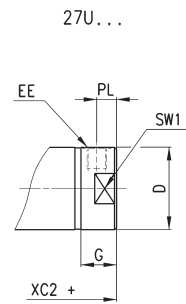
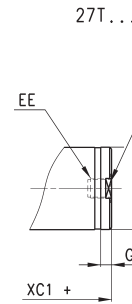
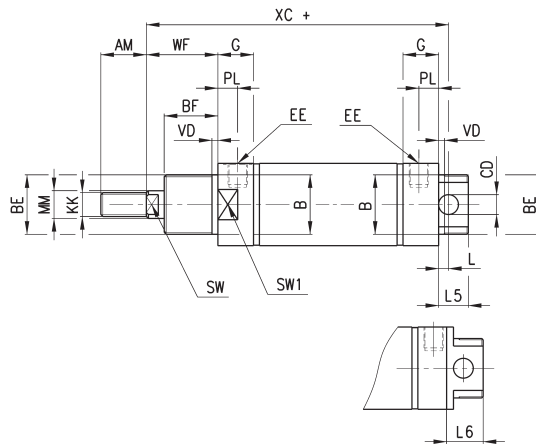

INGOMBRI

Ø	AM	øB	BF	BE	øCD ^{H9}	øD	EE	EW	G	G1	KK	L	L6	MM ^{H9}	L5	PL	SW	VD	WF	XC+	XC1+	XC2+	SW1
20	14	16	12	M16x1,5	6	21,5	G1/8	12	15,5	8	M8x1,25	7	-	8	13	9	7	3	17	77	62,5	70,8	19
25	16	18	12	M18x1,5	8	26,5	G1/8	14	15,5	8	M10x1,25	9	-	10	17	9	9	3	16,5	78,5	62	69,5	24
32	22	22	15	M22x1,5	8	33,5	G1/8	16	17,5	5,5	M10x1,25	7	20	12	15	9	10	3	23	93	74	86	30
40	23	30	15	M30x1,5	10	41,5	G1/8	20	18	5,5	M12x1,25	5	24	16	15	10	13	3	24	96	78,5	91	38

Cilindri Serie 27 (Ø 50, 63)



+ = sommare la corsa

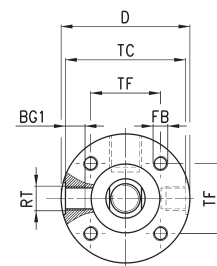
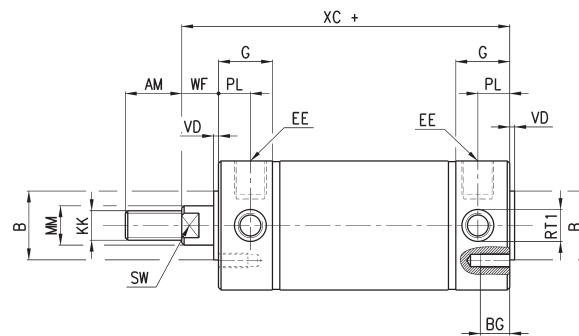

INGOMBRI

Ø	AM	øB	BG	BG1	øD	EE	FB	G	KK	øMM ^{H9}	PL	RT	RT1	SW	TC	TF	VD	WF	XC +
50	23	28	12	8	52,5	G1/4	M6	22	M12x1,25	16	13	M10x1	13	13	49	28,5	2	13	97
63	30	35	12	9,5	65,5	G1/4	M8	22	M16x1,5	20	13	M12x1,5	15	17	62	35,5	2	13	99

Ancoraggio a piedini Mod. B

Materiale: Acciaio zincato

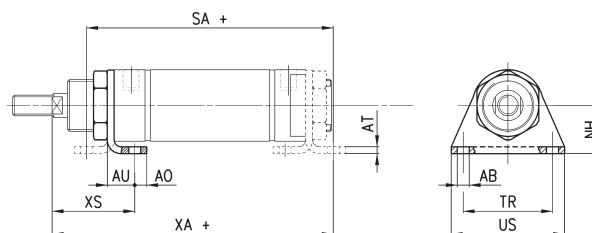
 La fornitura comprende:
 N° 1 piedino
 N° 1 ghiera mod. V

+ = sommare la corsa

INGOMBRI

Mod.	∅	∅AB	AO	AT	AU	NH	SA+	TR	US	XA+	XS
B-27-20	20	5,5	6	3	13	20	79	32	42	83	27
B-27-25	25	6,6	8	3	12,5	22	78	38	49	82	26
B-27-32	32	6,6	8	4	16	25	95	40	54	102	35
B-27-40	40	7	7	4	16	28	99	52	66	107	36

Ancoraggio a piedini Mod. B

Materiale: Acciaio zincato

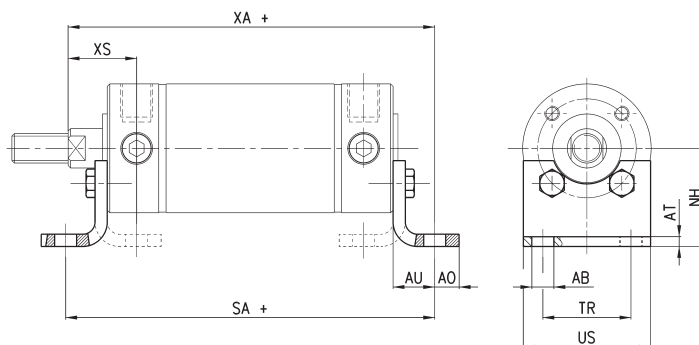
 La fornitura comprende:
 N° 2 piedini
 N° 4 viti

+ = sommare la corsa

INGOMBRI

Mod.	∅	∅AB	AO	AT	AU	NH	SA+	TR	US	XA+	XS
B-27-50	50	9	10	4	17	40	118	36	52	114	26
B-27-63	63	9	10	5	19	47	124	45	61	118	27

Ancoraggio a perno Mod. T

Materiale: Acciaio Inox

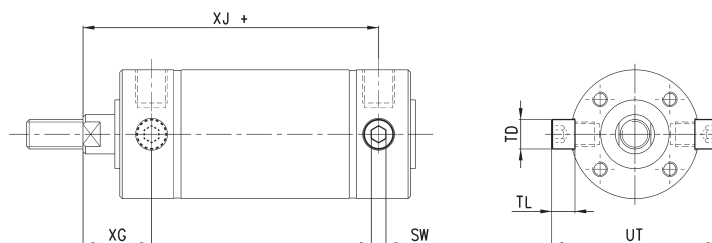
 La fornitura comprende:
 N° 2 perni

+ = sommare la corsa

INGOMBRI

Mod.	∅	SW	TD ⁹⁰	TL	UT	XG	XJ+
T-27-50	50	6	12	9,5	68	26	84
T-27-63	63	6	14	11	84	26	86

Ancoraggio a controcerniera Mod. I (Ø 20, 25, 32, 40)

Materiale: Acciaio zincato

La fornitura comprende:
 N° 1 cerniera femmina
 N° 1 perno
 N° 2 Seeger

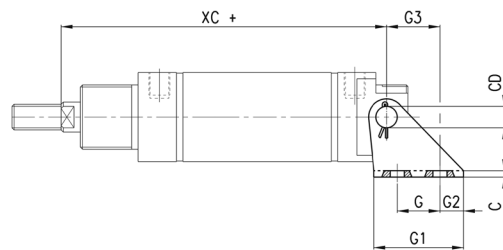
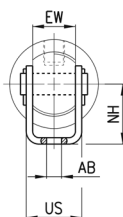
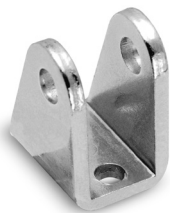

+ = sommare la corsa

INGOMBRI												
Mod.	Ø	G	G1	G2	G3	C	XC+	∅AB	US	NH	∅CD	EW
I-27-20	20	15	30	8	18,5	1,5	77	5,5	15	20	6	12
I-27-25	25	15	33	9	20	2	78,5	6,6	18	22	8	14
I-27-32	32	15	35	10	20	2	93	6,6	20,5	25	8	16
I-27-40	40	20	42	11	25	3	96	7	26	28	10	20

Ancoraggio a controcerniera Mod. I (Ø 50 - 63)

Materiale: Acciaio zincato

La fornitura comprende:
 N° 2 perni
 N° 2 piedini

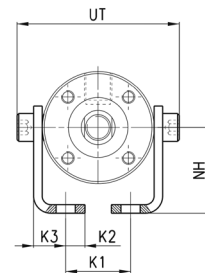
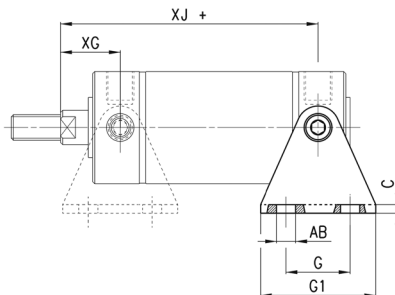

+ = sommare la corsa

INGOMBRI													
Mod.	Ø	G	G1	C	XJ+	XG	∅AB	K1	K1	K2	K3	NH	UT
I-27-50	50	30	54	4	84	26	9	9	30,5	9	15	40	68
I-27-63	63	40	64	5	86	26	9	9	40,5	9	17,5	47	84

Forcella Mod. G

ISO 8140
 Materiale: Acciaio zincato

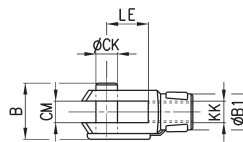
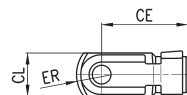

+ = sommare la corsa

INGOMBRI										
Mod.	Ø	∅CK	LE	CM	CL	ER	CE	KK	B	∅B1
G-20	20	8	16	8	16	10	32	M8x1,25	22	14
G-25-32	25-32	10	20	10	20	12	40	M10x1,25	26	18
G-40	40-50	12	24	12	24	14	48	M12x1,25	32	20
G-50-63	63	16	32	16	32	19	64	M16x1,5	40	26

Snodo sferico Mod. GA

ISO 8139

Materiale: Acciaio zincato

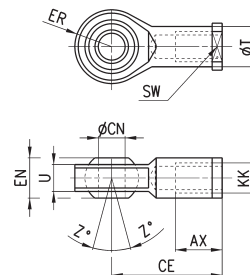
INGOMBRI

Mod.	Ø	ØCN ^(H7)	U	EN	ER	AX	CE	KK	ØT	Z	SW
GA-20	20	8	9	12	12	16	36	M8x1,25	12,5	6,5	14
GA-32	25-32	10	10,5	14	14	20	43	M10x1,25	15	6,5	17
GA-40	40-50	12	12	16	16	22	50	M12x1,25	17,5	6,5	19
GA-50-63	63	16	15	21	21	28	64	M16x1,5	22	7,5	22

Snodo sferico maschio Mod. GY

Materiale: Zama e Acciaio zincato

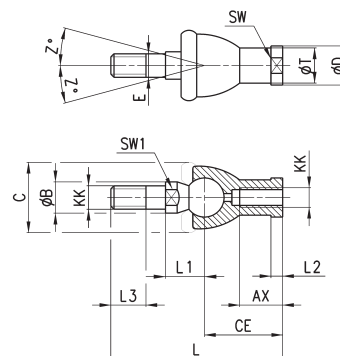

INGOMBRI

Mod.	Ø	KK	L	CE	L2	AX	E	ØB	ØC	T	D	L1	L3	SW1	SW	Z
GY-20	20	M8X1,25	65	32	5	16	8	12	24	12,5	16	16	12	10	14	15
GY-32	25-32	M10X1,25	74	35	6,5	18	10	14	28	15	19	19,5	15	11	17	15
GY-40	40-50	M12X1,25	84	40	6,5	20	12	19	32	17,5	22	21	17	17	19	15
GY-50-63	63	M16X1,5	112	50	8	27	16	22	40	22	27	27,5	23	19	22	11

Dado stelo Mod. U

UNI EN ISO 4035

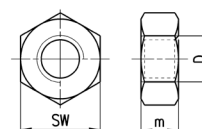
Materiale: Acciaio zincato

INGOMBRI

Mod.	Ø	D	m	SW
U-20	20	M8X1,25	5	13
U-25-32	20-32	M10X1,25	6	17
U-40	40-50	M12X1,25	7	19
U-50-63	63	M16X1,5	8	24

Ghiera Mod. V

UNI EN ISO 4035

V-27-25 / V-42-32 non a norma

Materiale: Acciaio zincato

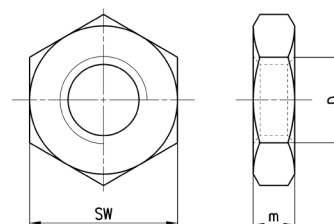
INGOMBRI

Mod.	Ø	D	m	SW
V-12-16	20	M16X1,5	6	24
V-27-25	25	M18X1,5	5	24
V-20-25	32	M22X1,5	10	32
V-42-32	40	M30x1,5	8	-

Snodo autoallineante Mod. GK

Materiale: Acciaio zincato

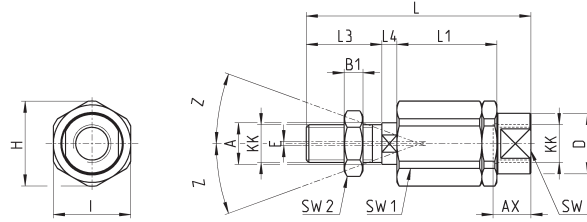

DIMENSIONI

Mod.	Ø	KK	L	L1	L3	L4	Ø A	Ø D	H	I	SW	SW1	SW2	B1	AX	Z	E
GK-20	20	M8x1,25	57	26	21	5	8	12,5	19	17	11	7	13	4	16	4	2
GK-25-32	25-32	M10x1,25	71,5	35	20	7,5	14	22	32	30	19	12	17	5	22	4	2
GK-40	40	M12x1,25	75,5	35	24	7,5	14	22	32	30	19	12	19	6	22	4	2
GK-50-63	50-63	M16x1,5	104	53	32	10	22	32	45	41	27	20	24	8	30	3	2

Giunto compensatore Mod. GKF

Materiale: Acciaio zincato

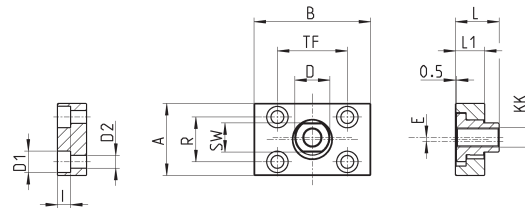

DIMENSIONI

Mod.	Ø	KK	A	B	R	TF	L	L1	I	Ø D	Ø D1	Ø D2	SW	E
GKF-20	20	M8x1,25	30	35	20	25	22,5	10	-	14	5,5	-	13	1,5
GKF-25-32	25-32	M10x1,25	37	60	23	36	22,5	15	6,8	18	11	6,6	15	2
GKF-40	40	M12x1,25	56	60	38	42	22,5	15	9	20	15	9	15	2,5
GKF-50-63	50-63	M16x1,5	80	80	58	58	26,5	15	10,5	25	18	11	22	2,5