

# Cilindri tondi Serie 27

Doppio effetto, magnetici  
 ø 20, 25, 32, 40, 50, 63 mm

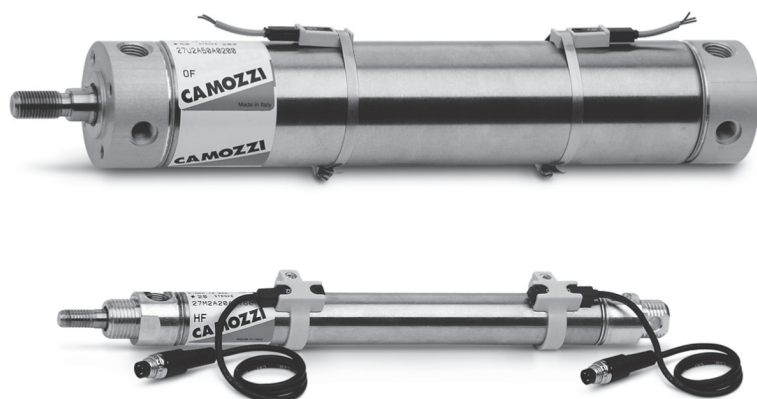

- » Ingombri ridotti
- » Versatilità nei fissaggi
- » Perfetta linearità dovuta alla bordatura

I cilindri Serie 27, costruiti con una linea estremamente pulita, sono stati realizzati cercando di ridurre al minimo gli ingombri. Camicia e stelo sono in acciaio Inox, mentre le testate sono in Alluminio.

Le soluzioni tecniche adottate e la scelta adeguata dei materiali ci hanno permesso di predisporre una serie di cilindri versatile e molto affidabile. Il particolare sistema di unione (bordatura) tra camicia e testata, infatti, assicura la perfetta linearità di tutti i particolari. Per rendere meno rumoroso l'impatto del pistone sulla testata, questi cilindri sono inoltre dotati di ammortizzatore meccanico. La Serie 27 è predisposta per il montaggio di sensori magnetici. Gli accessori di corredo ne consentono svariati fissaggi.

## CARATTERISTICHE GENERALI

<b>Tipo di costruzione</b>	bordato
<b>Funzionamento</b>	doppio effetto
<b>Materiali</b>	testate = AL - stelo e camicia = INOX - pistone = AL guarnizioni pistone e stelo = PU
<b>Tipo di fissaggio</b>	pedini - controcerniera - ghiera - perni
<b>Corse min-max</b>	tutti i diametri 10 - 1000 mm
<b>Alesaggi</b>	ø 20, 25, 32, 40, 50, 63
<b>Temperatura d'esercizio</b>	0°C + 80°C (con aria secca - 20°C)
<b>Pressione d'esercizio</b>	1 + 10 bar
<b>Velocità</b>	10 + 1000 mm/sec (senza carico)
<b>Fluido</b>	aria filtrata, senza lubrificazione. Nel caso si utilizzasse aria lubrificata, si consiglia olio ISOVG32 e di non interrompere mai la lubrificazione.

**TABELLA CORSE STANDARD PER CILINDRI A DOPPIO EFFETTO SERIE 27**

1

MOVIMENTO

Mod. 27M E 27T (ø 20 ÷ 40) e Mod. 27U (ø 20 ÷ 63)

## CORSE STANDARD

Ø	10	25	40	50	80	100	125	160	200	250	300	320	400	500
20	■	■	■	■	■	■	■	■	■	■	■	■	■	■
25	■	■	■	■	■	■	■	■	■	■	■	■	■	■
32	■	■	■	■	■	■	■	■	■	■	■	■	■	■
40	■	■	■	■	■	■	■	■	■	■	■	■	■	■
50	■	■	■	■	■	■	■	■	■	■	■	■	■	■
63	■	■	■	■	■	■	■	■	■	■	■	■	■	■

**ESEMPIO DI CODIFICA**

<b>27</b>	<b>M</b>	<b>2</b>	<b>A</b>	<b>20</b>	<b>A</b>	<b>0050</b>
-----------	----------	----------	----------	-----------	----------	-------------

<b>27</b>	SERIE		
<b>M</b>	VERSIONE M = testata posteriore con ancoraggio a cerniera per ø 20-25-32-40 T = testata posteriore con connessione assiale per ø 20-25-32-40 U = testata posteriore con connessione radiale per ø 20-25-32-40-50-63		
<b>2</b>	FUNZIONAMENTO 2 = doppio effetto		SIMBOLO PNEUMATICO CD08
<b>A</b>	CARATTERISTICHE MATERIALI A = stelo INOX rullato - camicia INOX		
<b>20</b>	ALESAGGIO 20 = 20 mm - 25 = 25 mm - 32 = 32 mm - 40 = 40 mm - 50 = 50 mm - 63 = 63 mm		
<b>A</b>	TIPO COSTRUTTIVO A = standard		
<b>0050</b>	CORSA (vedi tabella)		

**SIMBOLI PNEUMATICI**

I simboli pneumatici indicati nell'ESEMPIO DI CODIFICA sono riportati di seguito.



**ACCESSORI CILINDRI SERIE 27**
**1**

MOVIMENTO

 Giunto compensatore  
Mod. GKF

 Snodo autoallineante  
Mod. GK

 Ancoraggio a perno  
Mod. T

 Snodo sferico maschio  
Mod. GY

Snodo sferico Mod. GA



 Ancoraggio a piedini  
Mod. B

 Ancoraggio a piedini  
Mod. B

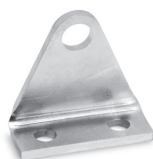

Ghiera Mod. V

 Ancoraggio a controcerniera  
Mod. I

Dado stelo Mod. U

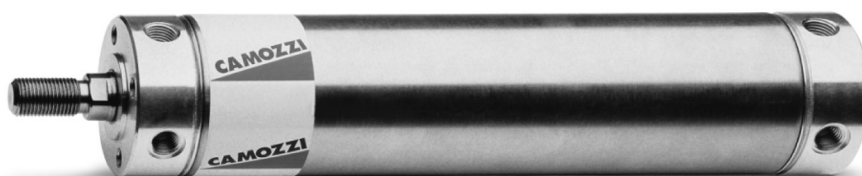

 Ancoraggio a controcerniera  
Mod. I

Forcella Mod. G

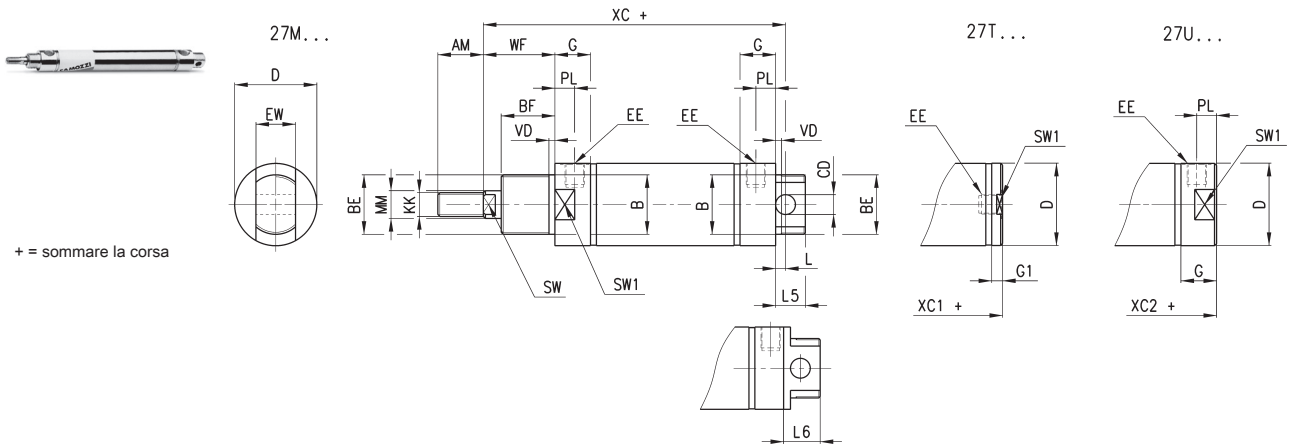

Tutti gli accessori sono forniti separatamente al cilindro.

Cilindri Serie 27 (Ø 20, 25, 32, 40)



INGOMBRI

Ø	AM	øB	BF	BE	øCD <sup>H9</sup>	øD	EE	EW	G	G1	KK	L	L6	MM <sup>H9</sup>	L5	PL	SW	VD	WF	XC+	XC1+	XC2+	SW1
20	14	16	12	M16x1,5	6	21,5	G1/8	12	15,5	8	M8x1,25	7	-	8	13	9	7	3	17	77	62,5	70,8	19
25	16	18	12	M18x1,5	8	26,5	G1/8	14	15,5	8	M10x1,25	9	-	10	17	9	9	3	16,5	78,5	62	69,5	24
32	22	22	15	M22x1,5	8	33,5	G1/8	16	17,5	5,5	M10x1,25	7	20	12	15	9	10	3	23	93	74	86	30
40	23	30	15	M30x1,5	10	41,5	G1/8	20	18	5,5	M12x1,25	5	24	16	15	10	13	3	24	96	78,5	91	38

Cilindri Serie 27 (Ø 50, 63)

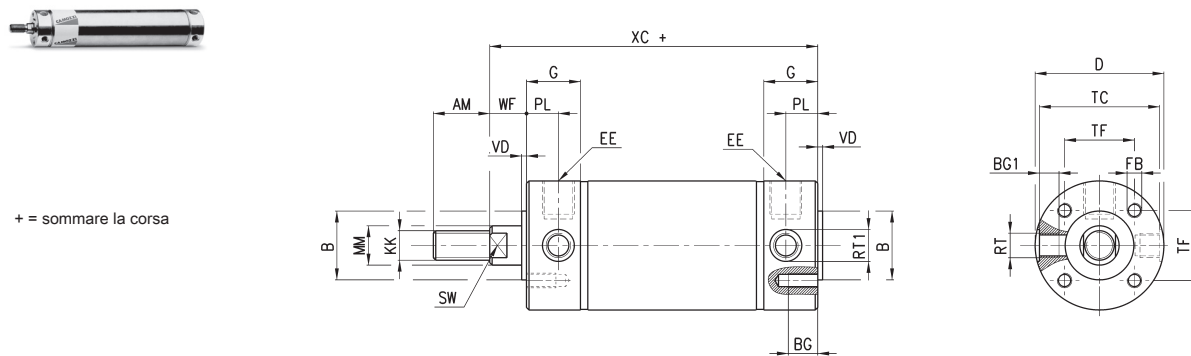

INGOMBRI

Ø	AM	øB	BG	BG1	øD	EE	FB	G	KK	øMM <sup>H9</sup>	PL	RT	RT1	SW	TC	TF	VD	WF	XC +
50	23	28	12	8	52,5	G1/4	M6	22	M12x1,25	16	13	M10x1	13	13	49	28,5	2	13	97
63	30	35	12	9,5	65,5	G1/4	M8	22	M16x1,5	20	13	M12x1,5	15	17	62	35,5	2	13	99

### Ancoraggio a piedini Mod. B

Materiale: Acciaio zincato

La fornitura comprende:  
N° 1 piedino  
N° 1 ghiera mod. V

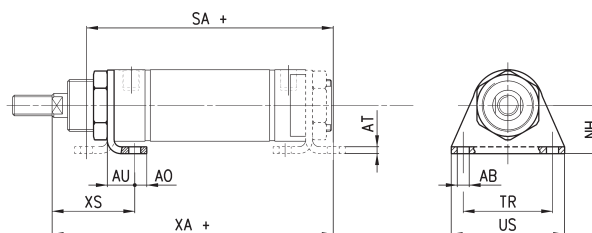

+ = sommare la corsa

#### INGOMBRI

Mod.	∅	∅AB	AO	AT	AU	NH	SA+	TR	US	XA+	XS
<b>B-27-20</b>	20	5,5	6	3	13	20	79	32	42	83	27
<b>B-27-25</b>	25	6,6	8	3	12,5	22	78	38	49	82	26
<b>B-27-32</b>	32	6,6	8	4	16	25	95	40	54	102	35
<b>B-27-40</b>	40	7	7	4	16	28	99	52	66	107	36

### Ancoraggio a piedini Mod. B

Materiale: Acciaio zincato

La fornitura comprende:  
N° 2 piedini  
N° 4 viti

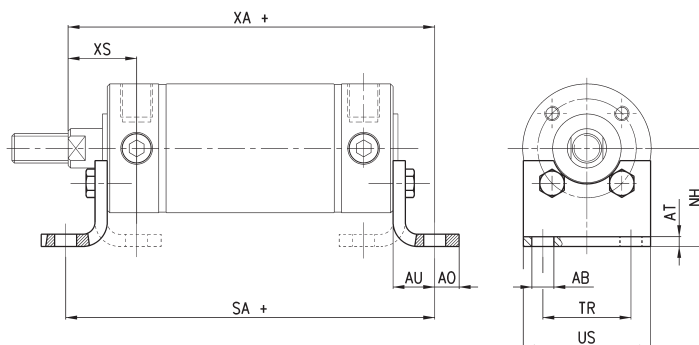

+ = sommare la corsa

#### INGOMBRI

Mod.	∅	∅AB	AO	AT	AU	NH	SA+	TR	US	XA+	XS
<b>B-27-50</b>	50	9	10	4	17	40	118	36	52	114	26
<b>B-27-63</b>	63	9	10	5	19	47	124	45	61	118	27

### Ancoraggio a perno Mod. T

Materiale: Acciaio Inox

La fornitura comprende:  
N° 2 perni

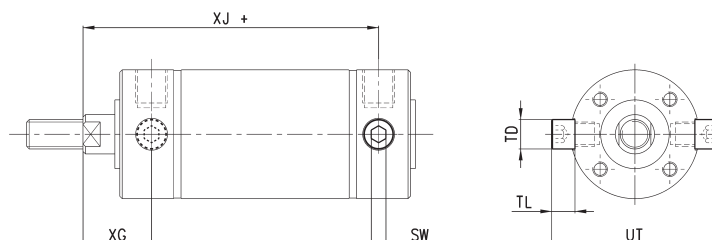

+ = sommare la corsa

#### INGOMBRI

Mod.	∅	SW	TD <sup>90</sup>	TL	UT	XG	XJ+
<b>T-27-50</b>	50	6	12	9,5	68	26	84
<b>T-27-63</b>	63	6	14	11	84	26	86

**Ancoraggio a controcerniera Mod. I (Ø 20, 25, 32, 40)**

Materiale: Acciaio zincato

La fornitura comprende:  
 N° 1 cerniera femmina  
 N° 1 perno  
 N° 2 Seeger

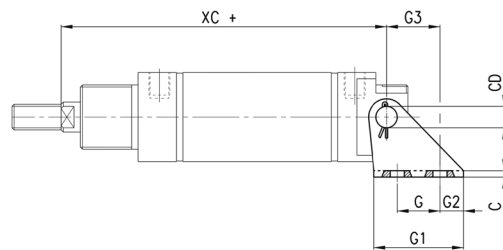
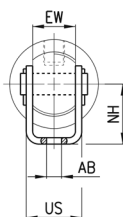
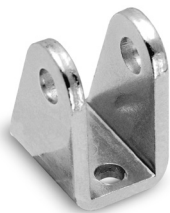

+ = sommare la corsa

INGOMBRI												
Mod.	Ø	G	G1	G2	G3	C	XC+	∅AB	US	NH	∅CD	EW
<b>I-27-20</b>	20	15	30	8	18,5	1,5	77	5,5	15	20	6	12
<b>I-27-25</b>	25	15	33	9	20	2	78,5	6,6	18	22	8	14
<b>I-27-32</b>	32	15	35	10	20	2	93	6,6	20,5	25	8	16
<b>I-27-40</b>	40	20	42	11	25	3	96	7	26	28	10	20

**Ancoraggio a controcerniera Mod. I (Ø 50 - 63)**

Materiale: Acciaio zincato

La fornitura comprende:  
 N° 2 perni  
 N° 2 piedini

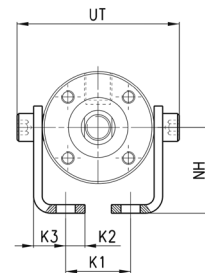
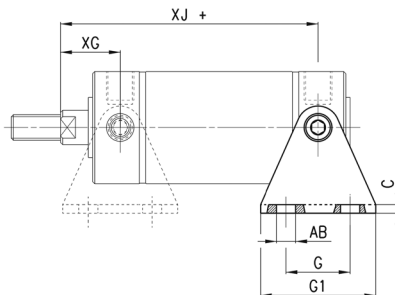

+ = sommare la corsa

INGOMBRI													
Mod.	Ø	G	G1	C	XJ+	XG	∅AB	K1	K1	K2	K3	NH	UT
<b>I-27-50</b>	50	30	54	4	84	26	9	9	30,5	9	15	40	68
<b>I-27-63</b>	63	40	64	5	86	26	9	9	40,5	9	17,5	47	84

**Forcella Mod. G**

ISO 8140  
 Materiale: Acciaio zincato

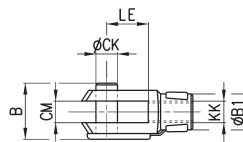
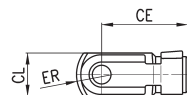

+ = sommare la corsa

INGOMBRI										
Mod.	Ø	∅CK	LE	CM	CL	ER	CE	KK	B	∅B1
<b>G-20</b>	20	8	16	8	16	10	32	M8x1,25	22	14
<b>G-25-32</b>	25-32	10	20	10	20	12	40	M10x1,25	26	18
<b>G-40</b>	40-50	12	24	12	24	14	48	M12x1,25	32	20
<b>G-50-63</b>	63	16	32	16	32	19	64	M16x1,5	40	26

**Snodo sferico Mod. GA**

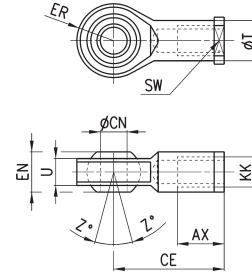
 ISO 8139  
 Materiale: Acciaio zincato

INGOMBRI												
Mod.	∅	∅CN <sup>(H7)</sup>	U	EN	ER	AX	CE	KK	∅T	Z	SW	
<b>GA-20</b>	20	8	9	12	12	16	36	M8x1,25	12,5	6,5	14	
<b>GA-32</b>	25-32	10	10,5	14	14	20	43	M10x1,25	15	6,5	17	
<b>GA-40</b>	40-50	12	12	16	16	22	50	M12x1,25	17,5	6,5	19	
<b>GA-50-63</b>	63	16	15	21	21	28	64	M16x1,5	22	7,5	22	

**Snodo sferico maschio Mod. GY**

Materiale: Zama e Acciaio zincato

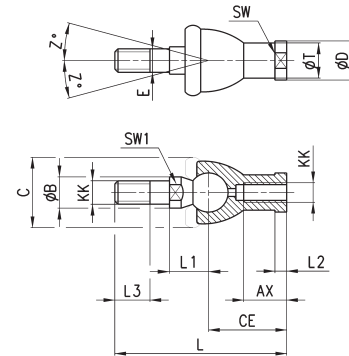

INGOMBRI																
Mod.	∅	KK	L	CE	L2	AX	E	∅B	∅C	T	D	L1	L3	SW1	SW	Z
<b>GY-20</b>	20	M8x1,25	65	32	5	16	8	12	24	12,5	16	16	12	10	14	15
<b>GY-32</b>	25-32	M10x1,25	74	35	6,5	18	10	14	28	15	19	19,5	15	11	17	15
<b>GY-40</b>	40-50	M12x1,25	84	40	6,5	20	12	19	32	17,5	22	21	17	17	19	15
<b>GY-50-63</b>	63	M16x1,5	112	50	8	27	16	22	40	22	27	27,5	23	19	22	11

**Dado stelo Mod. U**

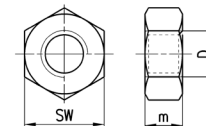
 UNI EN ISO 4035  
 Materiale: Acciaio zincato

INGOMBRI					
Mod.	∅		D	m	SW
<b>U-20</b>	20		M8x1,25	5	13
<b>U-25-32</b>	20-32		M10x1,25	6	17
<b>U-40</b>	40-50		M12x1,25	7	19
<b>U-50-63</b>	63		M16x1,5	8	24

**Ghiera Mod. V**

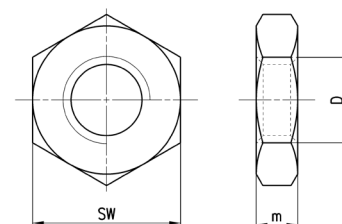
 UNI EN ISO 4035  
 V-27-25 / V-42-32 non a norma  
 Materiale: Acciaio zincato

INGOMBRI					
Mod.	∅		D	m	SW
<b>V-12-16</b>	20		M16x1,5	6	24
<b>V-27-25</b>	25		M18x1,5	5	24
<b>V-20-25</b>	32		M22x1,5	10	32
<b>V-42-32</b>	40		M30x1,5	8	-

### Snodo autoallineante Mod. GK

Materiale: Acciaio zincato

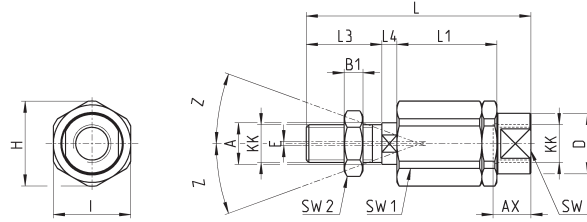

#### DIMENSIONI

Mod.	Ø	KK	L	L1	L3	L4	Ø A	Ø D	H	I	SW	SW1	SW2	B1	AX	Z	E
<b>GK-20</b>	20	M8x1,25	57	26	21	5	8	12,5	19	17	11	7	13	4	16	4	2
<b>GK-25-32</b>	25-32	M10x1,25	71,5	35	20	7,5	14	22	32	30	19	12	17	5	22	4	2
<b>GK-40</b>	40	M12x1,25	75,5	35	24	7,5	14	22	32	30	19	12	19	6	22	4	2
<b>GK-50-63</b>	50-63	M16x1,5	104	53	32	10	22	32	45	41	27	20	24	8	30	3	2

### Giunto compensatore Mod. GKF

Materiale: Acciaio zincato

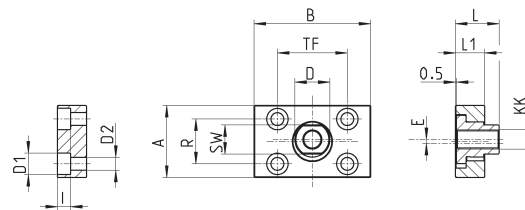

#### DIMENSIONI

Mod.	Ø	KK	A	B	R	TF	L	L1	I	Ø D	Ø D1	Ø D2	SW	E
<b>GKF-20</b>	20	M8x1,25	30	35	20	25	22,5	10	-	14	5,5	-	13	1,5
<b>GKF-25-32</b>	25-32	M10x1,25	37	60	23	36	22,5	15	6,8	18	11	6,6	15	2
<b>GKF-40</b>	40	M12x1,25	56	60	38	42	22,5	15	9	20	15	9	15	2,5
<b>GKF-50-63</b>	50-63	M16x1,5	80	80	58	58	26,5	15	10,5	25	18	11	22	2,5