

# Raccordi a calzamento per tubi plastici Serie 1000

Diametri esterni tubo: 5/3, 6/4, 8/6, 10/8, 12/10, 15/12,5 mm

Filetti dei raccordi: metrici (M5, M6, M12 x1, M12 x1,25), cilindrici (G1/8, G1/4, G3/8, G1/2), conici (R1/8, R1/4, R3/8, R1/2)

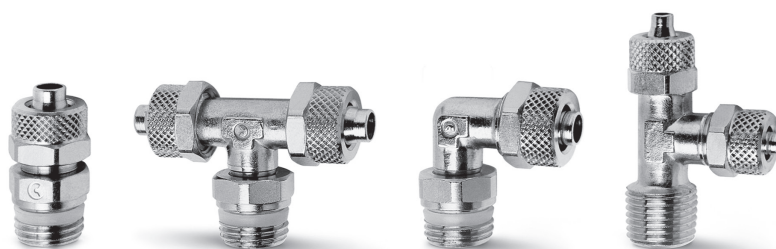

I raccordi rapidi della Serie 1000 a calzamento sono di facile installazione. I dadi di serraggio del calzamento si possono stringere con le mani oppure con l'ausilio di una chiave anche con tubi rigidi come il PA e il Poliestere Hytrel. La particolare forma del cono di conduzione evita possibili tagli del tubo.

## CARATTERISTICHE GENERALI

<b>Materiale</b>	corpo e dado: OT nichelato; O-ring: NBR; guarnizioni filetto: PTFE - PA, AL
<b>Filettature</b>	GAS conico ISO 7 (BSPT) GAS cilindrico ISO 228 (BSP) M5 - M6 NPT e metrico su richiesta
<b>Pressione</b>	la pressione nominale dei raccordi è sempre superiore alla pressione di utilizzo del tubo
<b>Tubo di collegamento</b>	PA polietilene, PVC intrecciato, rilsan, PU, Poliestere Hytrel
<b>Diametri</b>	5/3 - 6/4 - 8/6 - 10/8 - 12/10 - 15/12,5 mm
<b>Fluido</b>	aria compressa e fluidi a bassa pressione
<b>Temperatura</b>	-20°C + 80°C NB: per un utilizzo ottimale del raccordo è opportuno verificare le caratteristiche dei tubi impiegati.

## Raccordo con tubo di collegamento

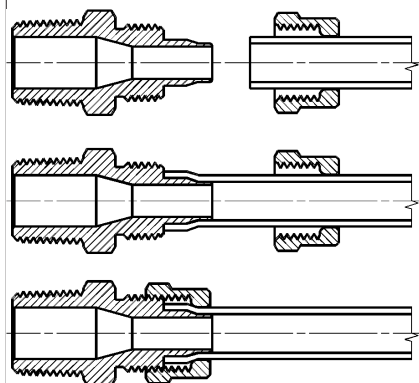

**Raccordi Mod. 1510**

Diritto Maschio Metrico-Conico

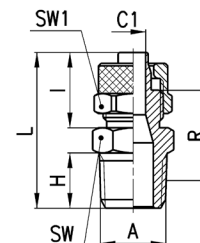

DIMENSIONI										
Mod.	Tubo	A	C1	H	I	L	R	SW	SW1	Peso (g)
1510 5/3-1/8	5/3	R1/8	2	7,5	12,5	24,5	14,5	12	8	10
1510 6/4-1/8	6/4	R1/8	3	7,5	15	27	16	12	12	15
1510 6/4-1/4	6/4	R1/4	3	11	15	31	18,5	14	12	19
1510 6/4-3/8	6/4	R3/8	3	11,5	15	31,5	18,5	17	12	22
1510 6/4-1/2	6/4	R1/2	3	14	15	34,5	20	22	12	38
1510 6/4-M12x1,25	6/4	M12X1,25	3	10	15	30	18	13	12	17
1510 8/6-1/8	8/6	R1/8	5	7,5	15	27	16	13	14	19
1510 8/6-1/4	8/6	R1/4	5	11	15	31	18,5	14	14	20
1510 8/6-3/8	8/6	R3/8	5	11,5	15	31,5	18,5	17	14	25
1510 8/6-1/2	8/6	R1/2	5	14	15	34,5	20	22	14	39
1510 10/8-1/8	10/8	R1/8	6,5	7,5	16,5	28,5	16,5	14	16	24
1510 10/8-1/4	10/8	R1/4	6,5	11	16,5	32,5	19	14	16	24
1510 10/8-3/8	10/8	R3/8	6,5	11,5	16,5	33	19	17	16	27
1510 10/8-1/2	10/8	R1/2	6,5	14	16,5	36	20,5	22	16	42
1510 12/10-3/8	12/10	R3/8	8,5	11,5	18	34,5	19	17	19	35
1510 12/10-1/2	12/10	R1/2	8,5	14	18	37,5	20,5	22	19	49
1510 15/12,5-1/2	15/12,5	R1/2	11	14	20	39,5	21	22	22	55

**Raccordi Mod. 1511**

Diritto Maschio Metrico Sprint®

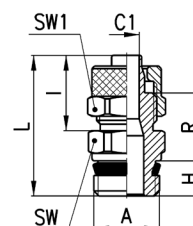

DIMENSIONI										
Mod.	Tubo	A	C1	H	I	L	R	SW	SW1	Peso (g)
1511 5/3-M5	5/3	M5	2	4	12,5	21	10,5	8	8	5 *
1511 5/3-M6	5/3	M6	2	4	12,5	21	10,5	9	8	5 *
1511 5/3-1/8	5/3	G1/8	2	5,5	12,5	23,8	11,8	12	8	10
1511 6/4-M5	6/4	M5	3	4	13,5	22	10,5	8	9	6 *
1511 6/4-M6	6/4	M6	3	4	13,5	22	10,5	9	9	7 *
1511 6/4-1/8	6/4	G1/8	3	5,5	15	26,3	13,3	12	12	15
1511 6/4-1/4	6/4	G1/4	3	7	15	28	13,5	14	12	16
1511 6/4-3/8	6/4	G3/8	3	8	15	29,3	13,8	19	12	27
1511 8/6-1/8	8/6	G1/8	5	5,5	15	26,3	13,3	12	14	17
1511 8/6-1/4	8/6	G1/4	5	7	15	28	13,5	14	14	18
1511 8/6-3/8	8/6	G3/8	5	8	15	29,3	13,8	19	14	27
1511 10/8-1/8	10/8	G1/8	6,5	5,5	16,5	27,8	13,8	14	16	23
1511 10/8-1/4	10/8	G1/4	6,5	7	16,5	29,5	14	14	16	25
1511 10/8-3/8	10/8	G3/8	6,5	8	16,5	30,8	14,3	19	16	30
1511 10/8-1/2	10/8	G1/2	6,5	9	16,5	32,5	15	22	16	36
1511 12/10-3/8	12/10	G3/8	8,5	8	18	32,3	14,3	19	19	39
1511 12/10-1/2	12/10	G1/2	8,5	9	18	34	15	22	19	42
1511 15/12,5-1/2	15/12,5	G1/2	11	9	20	36	15,5	22	22	52

\* = con O-Ring

Raccordi Mod. 1560

Diritto Maschio Girevole Sprint®

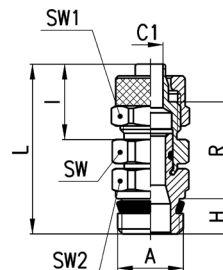

DIMENSIONI											
Mod.	Tubo	A	C1	H	I	L	R	SW	SW1	SW2	Peso (g)
1560 6/4-1/8	6/4	G1/8	3	5,5	15	31	18	12	12	12	19
1560 6/4-1/4	6/4	G1/4	3	7	15	32,5	18	12	12	14	25
1560 8/6-1/8	8/6	G1/8	5	5,5	15	32	19	13	14	12	21
1560 8/6-1/4	8/6	G1/4	5	7	15	33,5	19	13	14	14	26
1560 10/8-1/4	10/8	G1/4	6,5	7	16,5	34,5	19	14	16	14	27
1560 10/8-3/8	10/8	G3/8	6,5	8	16,5	36	19,5	14	16	19	38
1560 12/10-3/8	12/10	G3/8	6,5	8	18	38	20	17	19	19	46

Raccordi Mod. 1463

Diritto Femmina Cilindrico

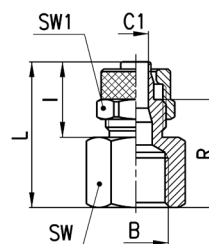

DIMENSIONI										
Mod.	Tubo	B	C1	I	L	R	SW	SW1	Peso (g)	
1463 5/3-1/8	5/3	G1/8	2	12,5	22,5	16	13	8	10	
1463 6/4-1/8	6/4	G1/8	3	15	25	17,5	13	12	14	
1463 6/4-1/4	6/4	G1/4	3	15	26,5	19	17	12	21	
1463 6/4-3/8	6/4	G3/8	3	15	27,5	20	20	12	25	
1463 8/6-1/8	8/6	G1/8	5	15	25	17,5	13	14	16	
1463 8/6-1/4	8/6	G1/4	5	15	26,5	19	17	14	22	
1463 8/6-3/8	8/6	G3/8	5	15	27,5	20	20	14	26	
1463 10/8-1/8	10/8	G1/8	6,5	16,5	21,5	13	14	16	19	
1463 10/8-1/4	10/8	G1/4	6,5	16,5	28	19,5	17	16	28	
1463 10/8-3/8	10/8	G3/8	6,5	16,5	29	20,5	20	16	31	
1463 10/8-1/2	10/8	G1/2	6,5	16,5	33	24,5	24	16	43	
1463 12/10-3/8	12/10	G3/8	8,5	18	30,5	20,5	20	19	37	

**Raccordi Mod. 1541**

Gomito Maschio Girevole Sprint®

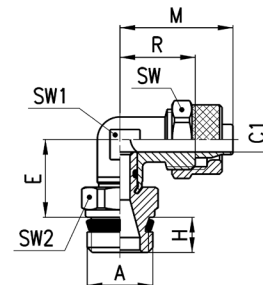
**DIMENSIONI**

Mod.	Tubo	A	C1	E	H	M	R	SW	SW1	SW2	Peso (g)
<b>1541 6/4-1/8</b>	6/4	G1/8	3	15	5,5	22,5	15	12	10	12	22
<b>1541 6/4-1/4</b>	6/4	G1/4	3	15	7	22,5	15	12	10	14	27
<b>1541 8/6-1/8</b>	8/6	G1/8	5	15	5,5	22,5	15	14	10	12	23
<b>1541 8/6-1/4</b>	8/6	G1/4	5	15	7	22,5	15	14	10	14	28
<b>1541 10/8-1/4</b>	10/8	G1/4	6,5	16	7	25,5	17	16	12	14	35

**Raccordi Mod. 1500**

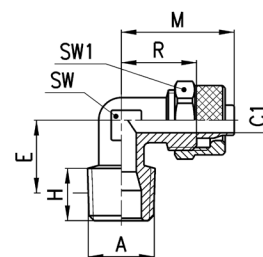
 Gomito Maschio Fisso  
Metrico-Conico

**DIMENSIONI**

Mod.	Tubo	A	C1	E	H	M	R	SW	SW1	Peso (g)
<b>1500 5/3-1/8</b>	5/3	R1/8	2	13	7,5	21,5	15	8	8	11
<b>1500 6/4-1/8</b>	6/4	R1/8	3	13	7,5	22,5	15	8	12	15
<b>1500 6/4-1/4</b>	6/4	R1/4	3	15,5	11	22,5	15	10	12	21
<b>1500 6/4-3/8</b>	6/4	R3/8	3	17	11,5	23,5	16	12	12	27
<b>1500 6/4-M12x1,25</b>	6/4	M12x1,25	3	14	10	22,5	15	10	12	18
<b>1500 8/6-1/8</b>	8/6	R1/8	5	13	7,5	22,5	15	10	14	19
<b>1500 8/6-1/4</b>	8/6	R1/4	5	15,5	11	22,5	15	10	14	21
<b>1500 8/6-3/8</b>	8/6	R3/8	5	17	11,5	24	16	12	14	29
<b>1500 8/6-1/2</b>	8/6	R1/2	5	21,5	14	27	19	16	14	48
<b>1500 10/8-1/8</b>	10/8	R1/8	6,5	15	7,5	25,5	17	12	16	29
<b>1500 10/8-1/4</b>	10/8	R1/4	6,5	17	11	25,5	17	12	16	29
<b>1500 10/8-3/8</b>	10/8	R3/8	6,5	16,5	11,5	25,5	17	12	16	33
<b>1500 10/8-1/2</b>	10/8	R1/2	6,5	21	14	28,5	20	16	16	58
<b>1500 12/10-3/8</b>	12/10	R3/8	8,5	19	11,5	30	20	14	19	44
<b>1500 12/10-1/2</b>	12/10	R1/2	8,5	21	14	30,5	20,5	16	19	59
<b>1500 15/12,5-1/2</b>	15/12,5	R1/2	11	21	14	34	22,5	16	22	67

## Raccordo Mod. 1501 5/3-M5

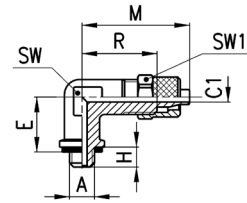
Gomito Maschio Fisso Metrico



## DIMENSIONI

Mod.	Tubo	A	C1	E	H	M	R	SW	SW1	Peso (g)
<b>1501 5/3-M5</b>	5/3	M5	2	11	4	21,5	15	8	8	10

## Raccordi Mod. 1493

Gomito Femmina Cilindrico

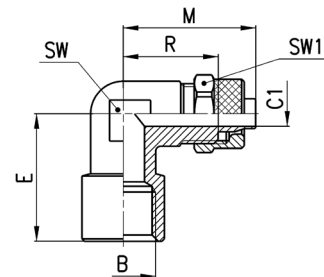

## DIMENSIONI

Mod.	Tubo	B	C1	E	M	R	SW	SW1	Peso (g)
<b>1493 6/4-1/8</b>	6/4	G1/8	3	19	22,5	15	10	12	20
<b>1493 6/4-1/4</b>	6/4	G1/4	3	23,5	26	18,5	14	12	34
<b>1493 8/6-1/8</b>	8/6	G1/8	5	19	22,5	15	10	14	21
<b>1493 8/6-1/4</b>	8/6	G1/4	5	23,5	26	19	14	14	34
<b>1493 10/8-1/4</b>	10/8	G1/4	6,5	23,5	27,5	18	14	16	39
<b>1493 12/10-3/8</b>	12/10	G3/8	8,5	24,5	30,5	20,5	16	19	53

## Raccordi Mod. 1431

T Maschio Girevole Sprint®

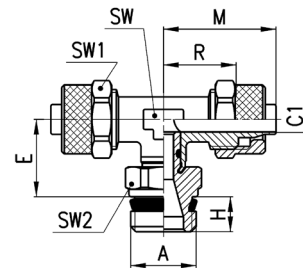

## DIMENSIONI

Mod.	Tubo	A	C1	E	H	M	R	SW	SW1	SW2	Peso (g)
<b>1431 6/4-1/8</b>	6/4	G1/8	3	15	5,5	22,5	15	10	12	12	32
<b>1431 6/4-1/4</b>	6/4	G1/4	3	15	7	22,5	15	10	12	14	38
<b>1431 8/6-1/8</b>	8/6	G1/8	5	15	5,5	22,5	15	10	14	12	36
<b>1431 8/6-1/4</b>	8/6	G1/4	5	15	7	22,5	15	10	14	14	41
<b>1431 10/8-1/4</b>	10/8	G1/4	6,5	16	7	25,5	17	12	16	14	54

**Raccordi Mod. 1410**

T Maschio Fisso Conico

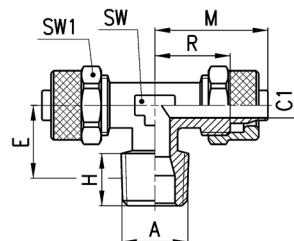
**DIMENSIONI**

Mod.	Tubo	A	C1	E	H	M	R	SW	SW1	Peso (g)
1410 5/3-1/8	5/3	R1/8	2	12,5	7,5	21,5	15	8	8	16
1410 6/4-1/8	6/4	R1/8	3	12,5	7,5	22,5	15	8	12	25
1410 6/4-1/4	6/4	R1/4	3	15,5	11	22,5	15	10	12	32
1410 8/6-1/8	8/6	R1/8	5	13	7,5	22,5	15	10	14	31
1410 8/6-1/4	8/6	R1/4	5	15,5	11	22,5	15	10	14	35
1410 10/8-1/8	10/8	R1/8	6,5	15	7,5	25,5	17	12	16	47
1410 10/8-1/4	10/8	R1/4	6,5	17	11	25,5	17	12	16	50
1410 10/8-1/2	10/8	R1/2	6,5	21,5	14	28,5	20	16	16	80
1410 12/10-3/8	12/10	R3/8	8,5	19	11,5	30	20	14	19	77
1410 12/10-1/2	12/10	R1/2	8,5	21,5	14	30,5	20,5	16	19	92
1410 15/12,5-1/2	15/12,5	R1/2	11	21,5	14	34	22,5	16	22	107

**Raccordi Mod. 1420**

T Maschio Laterale Conico

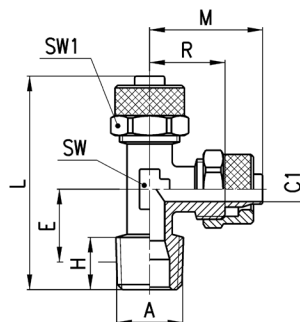
**DIMENSIONI**

Mod.	Tubo	A	C1	E	H	L	M	R	SW	SW1	Peso (g)
1420 5/3-1/8	5/3	R1/8	2	12,5	7,5	37,5	21,5	15	8	8	15
1420 6/4-1/8	6/4	R1/8	3	12,5	7,5	38,5	22,5	15	8	12	23
1420 6/4-1/4	6/4	R1/4	3	15,5	11	43	22,5	15	10	12	29
1420 8/6-1/8	8/6	R1/8	5	13	7,5	39	22,5	15	10	14	31
1420 8/6-1/4	8/6	R1/4	5	15,5	11	43	22,5	15	10	14	34
1420 10/8-1/8	10/8	R1/8	6,5	15	7,5	43,5	25,5	17	12	16	46
1420 10/8-1/4	10/8	R1/4	6,5	17	11	47	25,5	17	12	16	50

## Raccordi Mod. 1521

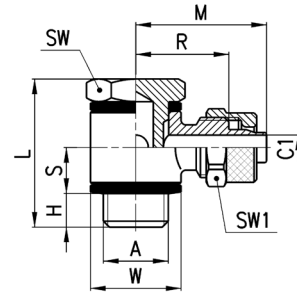
Vite Cava Metrica-Cilindrica Orientabile  
con Anello Singolo

## DIMENSIONI

Mod.	Tubo	A	C1	H	L	S	M	R	W	SW	SW1	Peso (g)
1521 5/3-M5	5/3	M5	2	3	18	4,5	17	10,5	Ø 9	8	8	10
1521 5/3-1/8	5/3	G1/8	2	6	27	8,5	22,5	16	Ø 14	14	8	26
1521 6/4-M5	6/4	M5	3	3	18	4,5	18	10,5	Ø 9	8	9	11
1521 6/4-1/8	6/4	G1/8	3	6	27	8,5	24	16,5	Ø 14	14	12	31
1521 6/4-1/4	6/4	G1/4	3	8	29,5	8,5	26	18,5	Ø 18	17	12	48
1521 6/4-3/8	6/4	G3/8	3	8	30	8,5	28	20,5	Ø 21	19	12	57
1521 8/6-1/8	8/6	G1/8	5	6	27	8,5	24	16,5	Ø 14	14	14	34
1521 8/6-1/4	8/6	G1/4	5	8	29,5	8,5	26	18,5	Ø 18	17	14	46
1521 8/6-3/8	8/6	G3/8	5	8	30	8,5	28	20,5	Ø 21	19	14	64

## Raccordi Mod. 1525

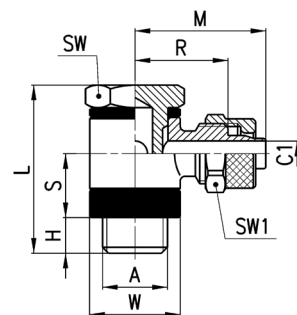
Vite Cava Lunga Cilindrica Orientabile  
con Anello Singolo

## DIMENSIONI

Mod.	Tubo	A	C1	H	L	S	M	R	W	SW	SW1	Peso (g)
1525 6/4-1/8	6/4	G1/8	3	6	31	12,5	24	16,5	Ø14	14	12	35
1525 6/4-1/4	6/4	G1/4	3	8	33,5	12,5	26	18,5	Ø18	17	12	48
1525 6/4-3/8	6/4	G3/8	3	8	34	12,5	28	20,5	Ø21	19	12	60
1525 8/6-1/8	8/6	G1/8	5	6	31	12,5	24	16,5	Ø14	14	14	35
1525 8/6-1/4	8/6	G1/4	5	8	33,5	12,5	26	18,5	Ø18	17	14	54
1525 8/6-3/8	8/6	G3/8	5	8	34	12,5	28	20,5	Ø21	19	14	64
1525 10/8-1/8	10/8	G1/8	6,5	6	31	12,5	25	16,5	Ø14	14	16	38
1525 10/8-1/4	10/8	G1/4	6,5	8	33,5	12,5	27	18,5	Ø18	17	16	57
1525 10/8-3/8	10/8	G3/8	6,5	8	34	12,5	29,5	21	Ø21	19	16	69
1525 10/8-1/2	10/8	G1/2	6,5	9	35	12,5	32	23,5	Ø26	27	16	112
1525 12/10-3/8	12/10	G3/8	8	8	34	12,5	31,5	21,5	Ø21	19	19	77
1525 12/10-1/2	12/10	G1/2	8,5	9	35	12,5	33,5	23,5	Ø26	27	19	111
1525 15/12,5-1/2	15/12,5	G1/2	11	9	35	12,5	36,5	25	Ø26	27	22	120

**Raccordi Mod. 1610**

Anello Singolo

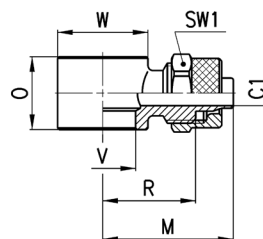

DIMENSIONI										
Mod.	Tubo	C1	M	O	R	V	W	SW1	Peso (g)	assemblabile con Mod.
1610 5/3-M5	5/3	2	17	9	10.5	5.1	Ø 9	8	8	1631, 1635
1610 5/3-M6	5/3	2	17	9	10.5	5.1	Ø 9	8	7	SCU, SVU, SCO...
1610 5/3-1/8	5/3	2	22.5	14.5	16	9.8	Ø 14	8	13	1631, 1635, SCU, SVU, SCO...
1610 6/4-M5	6/4	3	18	9	10.5	5.1	Ø 9	9	8	1631, 1635
1610 6/4-M6	6/4	2	18	9	10.5	5.1	Ø 9	9	8	SCU, SVU, SCO...
1610 6/4-1/8	6/4	3	24	14.5	16.5	9.8	Ø 14	12	18	1631, 1635, SCU, SVU, SCO...
1610 6/4-1/4	6/4	3	26	14.5	18.5	13.2	Ø 18	12	21	1631, 1635, SCU, SVU, SCO...
1610 6/4-3/8	6/4	3	28	14.5	20.5	16.7	Ø 21	12	22	1631, 1635, SCU, SVU, SCO...
1610 8/6-1/8	8/6	5	24	14.5	16.5	9.8	Ø 14	14	19	1631, 1635, SCU, SVU, SCO...
1610 8/6-1/4	8/6	5	26	14.5	18.5	13.2	Ø 18	14	22	1631, 1635, SCU, SVU, SCO...
1610 8/6-3/8	8/6	5	28	14.5	20.5	16.7	Ø 21	14	25	1631, 1635, SCU, SVU, SCO...
1610 10/8-1/8	10/8	6.5	25	14.5	16.5	9.8	Ø 14	16	25	1635, SCU, SVU, SCO...
1610 10/8-1/4	10/8	6.5	27	14.5	18.5	13.2	Ø 18	16	24	1635, SCU, SVU, SCO...
1610 10/8-3/8	10/8	6.5	29.5	14.5	21	16.7	Ø 21	16	28	1635, SCU, SVU, SCO...
1610 10/8-1/2	10/8	6.5	32	14.5	23.5	21	Ø 26	16	35	1635
1610 12/10-3/8	12/10	8	31.5	14.5	21.5	16.7	Ø 21	19	36	1635, SCU, SVU, SCO...
1610 12/10-1/2	12/10	8.5	33.5	14.5	23.5	21	Ø 26	19	40	1635
1610 15/12,5-1/2	15/12,5	11	36.5	14.5	25	21	Ø 26	22	48	1635

**Raccordi Mod. 1620**

Anello Doppio

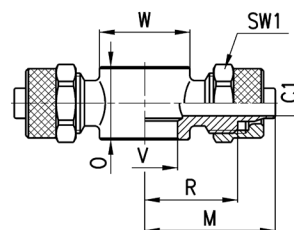

DIMENSIONI										
Mod.	Tubo	C1	M	O	R	V	W	SW1	Peso (g)	assemblabile con Mod.
1620 6/4-M5	6/4	3	18	9	10.5	5.1	Ø 9	9	12	1631, 1635
1620 6/4-1/8	6/4	3	24	14.5	16.5	9.8	Ø 14	12	29	1631, 1635, SCU, SVU, SCO...
1620 6/4-1/4	6/4	3	26	14.5	18.5	13.2	Ø 18	12	31	1631, 1635, SCU, SVU, SCO...
1620 8/6-1/8	8/6	5	24	14.5	16.5	9.8	Ø 14	14	31	1631, 1635, SCU, SVU, SCO...
1620 8/6-1/4	8/6	5	26	14.5	18.5	13.2	Ø 18	14	34	1631, 1635, SCU, SVU, SCO...



## Raccordi Mod. 1631 01

## Vite Cava Singola



Assemblabili con i raccordi orientabili Mod. 6610;  
6620; 1610; 1620; 2023; 1170

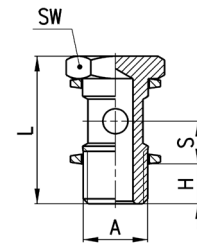

## DIMENSIONI

Mod.	A	H	L	S	SW	Peso (g)
<b>1631 01-M5</b>	M5	4	18	5,5	8	3 *
<b>1631 01-1/8</b>	G1/8	6	27	8,5	14	13
<b>1631 01-1/4</b>	G1/4	8	29,5	8,5	17	24
<b>1631 01-3/8</b>	G3/8	8	30	8,5	19	35
<b>1631 01-1/2</b>	G1/2	9	31	8,5	27	63

\* = Acciaio zincato

## Raccordi Mod. 1635 01

## Vite Cava Lunga Singola



Assemblabili con i raccordi orientabili modello 6610;  
6620; 1610; 1620; 2023; 1170

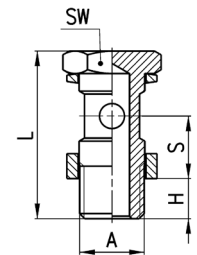

## DIMENSIONI

Mod.	A	H	L	S	SW	Peso (g)
<b>1635 01-1/8</b>	G1/8	6	31	12,5	14	15
<b>1635 01-1/4</b>	G1/4	8	33,5	12,5	17	27
<b>1635 01-3/8</b>	G3/8	8	34	12,5	19	37
<b>1635 01-1/2</b>	G1/2	9	35	12,5	27	71
<b>1635 01-M12x1,25</b>	M12x1,25	8	33,5	12,5	17	27 *
<b>1635 01-M12x1,5</b>	M12x1,5	8	33,5	12,5	17	27 *

\* = modelli assemblabili con  
raccordi orientabili da 1/4

## Raccordi Mod. 1631 02

## Vite Cava Doppia



Assemblabili con i raccordi orientabili modello 6610;  
6620; 1610; 1620; 2023; 1170

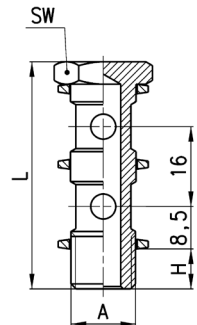

## DIMENSIONI

Mod.	A	H	L	SW	Peso (g)
<b>1631 02-1/8</b>	G1/8	6	43	14	18
<b>1631 02-1/4</b>	G1/4	8	45,5	17	33
<b>1631 02-3/8</b>	G3/8	8	46	19	48

**Raccordi Mod. 1635 02**

Vite Cava Lunga Doppia

Assemblabili con i raccordi orientabili modello 6610; 6620; 1610; 1620; 2023; 1170

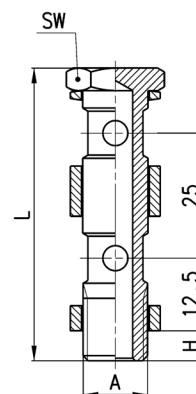

**DIMENSIONI**

Mod.	A	H	L	SW	Peso (g)
<b>1635 02-1/8</b>	G1/8	6	56	14	26
<b>1635 02-1/4</b>	G1/4	8	58,5	17	33
<b>1635 02-3/8</b>	G3/8	8	59	19	64
<b>1635 02-1/2</b>	G1/2	9	60	27	111

**Raccordi Mod. 1631 03**

Vite Cava Tripla

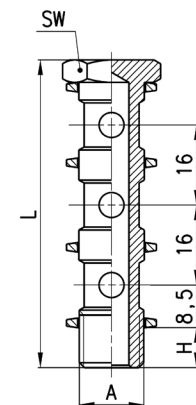
Assemblabili con i raccordi orientabili modello 6610; 6620; 1610; 1620; 2023; 1170

**DIMENSIONI**

Mod.	A	H	L	SW	Peso (g)
<b>1631 03-1/8</b>	G1/8	6	59	14	24
<b>1631 03-1/4</b>	G1/4	8	61,5	17	42
<b>1631 03-3/8</b>	G3/8	8	62	19	62

**Raccordi Mod. 1580**

Dritto Intermedio

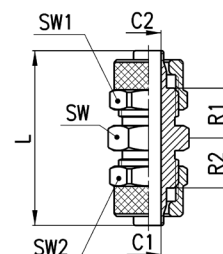
**DIMENSIONI**

Mod.	Tubo	C1	C2	L	R1	R2	SW	SW1	SW2	Peso (g)
<b>1580 5/3</b>	5/3	2	2	28,5	7,5	7,5	8	8	8	8
<b>1580 6/4</b>	6/4	3	3	34,5	10	10	12	12	12	22
<b>1580 8/6</b>	8/6	5	5	34,5	9,75	9,75	13	14	14	28
<b>1580 10/8</b>	10/8	6,5	6,5	38	10,5	10,5	14	16	16	38
<b>1580 12/10</b>	12/10	8,5	8,5	41	10,5	10,5	17	19	19	55
<b>1580 15/12,5</b>	15/12,5	11	11	45	11	11	22	22	22	80
<b>1580 8/6-6/4</b>	8/6-6/4	5	3	34,5	9,75	9,75	13	12	14	24
<b>1580 10/8-6/4</b>	10/8-6/4	6,5	3	36,5	10,5	10	14	12	16	31

Raccordi Mod. 1590

Diritto Passaparete - Ridotto

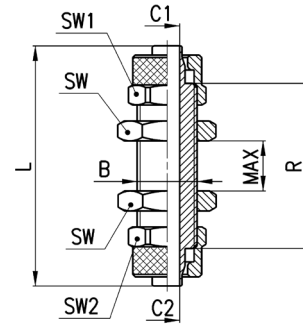

DIMENSIONI											
Mod.	Tubo	B	C1	C2	L	R	MAX	SW	SW1	SW2	Peso (g)
1590 5/3	5/3	M7x0,75	2	2	40	27	9	8	8	8	12
1590 6/4	6/4	M10x1	3	3	48	33	14	14	12	12	33
1590 8/6	8/6	M12x1	5	5	48	33	12	17	14	14	43
1590 10/8	10/8	M14x1	6,5	6,5	48	31	10	17	16	16	52
1590 12/10	12/10	M16x1	8,5	8,5	53	33	10	19	19	19	71
1590 6/4-5/3	6/4-5/3	M10x1	3	2	48	34	14	14	12	12	33
1590 8/6-6/4	8/6-6/4	M12x1	5	3	48	33	12	17	14	14	44

Raccordi Mod. 1550

Gomito Intermedio

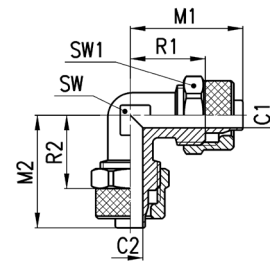

DIMENSIONI										
Mod.	Tubo	C1	C2	M1	M2	R1	R2	SW	SW1	Peso (g)
1550 6/4	6/4	3	3	22,5	22,5	15	15	8	12	21
1550 8/6	8/6	5	5	22,5	22,5	15	15	10	14	27
1550 10/8	10/8	6,5	6,5	25,5	25,5	17	17	12	16	40
1550 12/10	12/10	8,5	8,5	30	30	20	20	14	19	61
1550 15/12,5	15/12,5	11	11	34	34	22,5	22,5	16	22	88

Raccordi Mod. 1540

T Intermedio

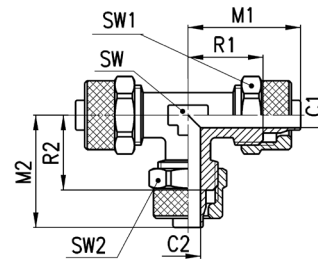

DIMENSIONI											
Mod.	Tubo	C1	C2	M1	M2	R1	R2	SW	SW1	SW2	Peso (g)
1540 5/3	5/3	2	2	21,5	21,5	15	15	8	8	8	17
1540 6/4	6/4	3	3	22,5	22,5	15	15	8	12	12	31
1540 8/6	8/6	5	5	22,5	22,5	15	15	10	14	14	39
1540 10/8	10/8	6,5	6,5	25,5	25,5	17	17	12	16	16	58
1540 12/10	12/10	8,5	8,5	30	30	20	20	14	19	19	90
1540 15/12,5	15/12,5	11	11	34	34	22,5	22,5	16	22	22	128
1540 8/6-6/4	8/6-6/4	5	3	22,5	22,5	15	15	10	14	12	38
1540 10/8-6/4	10/8-6/4	6,5	3	25,5	23,5	17	16,5	12	16	12	50
1540 10/8-8/6	10/8-8/6	6,5	5	25,5	24	17	16,5	12	16	14	53

**Raccordi Mod. 1600**

Croce Intermedia

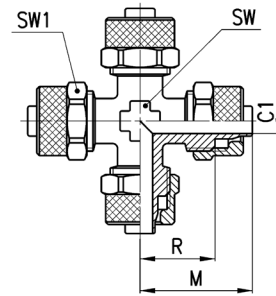
**DIMENSIONI**

Mod.	Tubo	C1	M	R	SW	SW1	Peso (g)
<b>1600 6/4</b>	6/4	3	22,5	15	8	12	41
<b>1600 8/6</b>	8/6	5	22,5	15	10	14	52

**Raccordi Mod. 1470**

Adattatore con Codolo

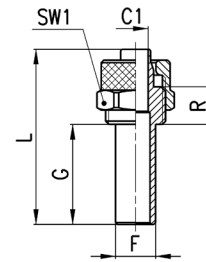
**DIMENSIONI**

Mod.	Tubo	F	C1	G	L	R	SW1	Peso (g)
<b>1470 6/4</b>	6/4	6	3	20	35	7,5	12	11
<b>1470 8/6</b>	8/6	8	5	20	35	7,5	14	15

**Accessori Mod. 2651**

Anello di tenuta in alluminio

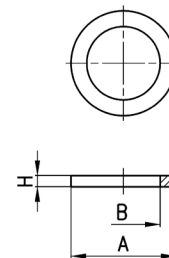
**DIMENSIONI**

Mod.	A	B	H	Peso (g)
<b>2651 1/8</b>	14	9,8	1,5	1
<b>2651 1/4</b>	18	13,2	1,5	1
<b>2651 3/8</b>	22	16,7	1,5	1
<b>2651 1/2</b>	26	20,9	1,5	1
<b>2651 1</b>	38,5	33,4	1,5	2

## Accessori Mod. 2661

Anello di tenuta dentellata in plastica

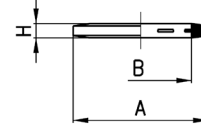

## DIMENSIONI

Mod.	A	B	H	Peso (g)
<b>2661 M3</b>	4,9	2,8	0,7	1
<b>2661 M5</b>	8	5,2	1	1
<b>2661 M6</b>	9	6,2	1	1
<b>2661 1/8</b>	14	10,2	1,9	1
<b>2661 1/4</b>	18	13,5	1,9	1
<b>2661 3/8</b>	21	16,5	2,1	1
<b>2661 1/2</b>	26	21,2	1,9	1

## Accessori Mod. 2665

Anello di tenuta in plastica

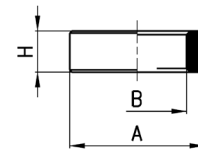

## DIMENSIONI

Mod.	A	B	H	Peso (g)
<b>2665 1/8</b>	14	9,8	5	1
<b>2665 1/4</b>	18	13,2	5	1
<b>2665 3/8</b>	21	16,8	5	1
<b>2665 1/2</b>	26	21,1	5	1

## Accessori Mod. 2669

Anello di tenuta alto in plastica

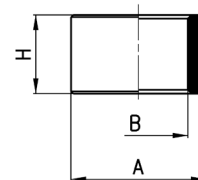

## DIMENSIONI

Mod.	A	B	H	Peso (g)
<b>2669 1/8</b>	14	9,8	10	1
<b>2669 1/4</b>	18	13,2	10	2
<b>2669 3/8</b>	21	16,8	10	2
<b>2669 1/2</b>	26	21,1	10	2

**Accessori Mod. 1703**

Dado di bloccaggio

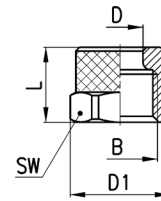
**DIMENSIONI**

Mod.	Tubo	B	D	D1	L	SW1	Peso (g)
<b>1703 5/3-M7x0,75</b>	5/3	M7x0,75	5,1	8,8	8,5	8	1
<b>1703 6/4-M8x0,75</b>	6/4	M8x0,75	6,1	9,8	8,5	9	2
<b>1703 6/4-M10x1</b>	6/4	M10x1	6,1	13,3	10	12	4
<b>1703 8/6-M12x1</b>	8/6	M12x1	8,2	15,5	10	14	5
<b>1703 10/8-M14x1</b>	10/8	M14x1	10,15	17,5	13	16	8
<b>1703 12/10-M16x1</b>	12/10	M16x1	12,2	21	13,5	19	12
<b>1703 15/12,5-M20x1</b>	15/12,5	M20x1	15,2	24,5	16	22	15

**Accessori Mod. 1723**

Dado di bloccaggio con Molla in metallo

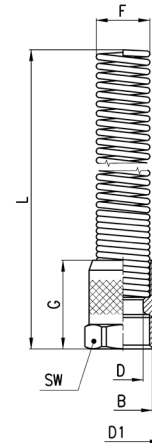
**DIMENSIONI**

Mod.	Tubo	B	F	D	D1	G	L	SW	Peso (g)
<b>1723 6/4-M10x1</b>	6/4	M10x1	8,9	6,1	13,3	18	90,5	12	15
<b>1723 8/6-M12x1</b>	8/6	M12x1	10,9	8,2	15,5	18	94,5	14	23
<b>1723 10/8-M14x1</b>	10/8	M14x1	12,5	10,15	17,5	22	96,5	16	29
<b>1723 12/10-M16x1</b>	12/10	M16x1	15,5	12,2	21	23,5	108	19	46
<b>1723 15/12,5-M20x1</b>	15/12,5	M20x1	18,5	15,2	24,5	28	120	22	57