

Raccordi super-rapidi in ottone Serie 6000 per tubi plastici

Diametri esterni tubo: 3, 4, 5, 6, 8, 10, 12, 14, 16 mm
Filetti dei raccordi: metrici (M3, M5, M6, M7), cilindrici (G1/8, G1/4, G3/8, G1/2, G3/4), conici (R1/8, R1/4, R3/8, R1/2)

RACCORDI SUPER-RAPIDI SERIE 6000 IN OTTONE



I raccordi super-rapidi Serie 6000 sono stati progettati e prodotti con una speciale pinza che permette una tenuta omogenea su tutta la superficie dei tubi in materiale plastico, garantendo un'ottima affidabilità nel tempo anche dopo molteplici inserimenti e disconnessioni del tubo. Sono inoltre disponibili diverse tipologie di filetti: metrici, cilindrici e conici.

I modelli Sprint® con sistema brevettato sono caratterizzati da una grande adattabilità dei filetti maschi con i filetti femmina cilindrici ISO-228 anche in presenza di superfici non piane o irregolari. Questo è possibile grazie ad un anello in Teflon posizionato sul filetto maschio, che garantisce una tenuta eccellente tra i due filetti.

La vasta gamma di questi raccordi comprende anche la versione LF ("Stop Fitting") dotata di autoritenuta, che impedisce il rilascio del flusso d'aria quando viene scollegato il tubo e lo ripristina una volta ricollegato.

CARATTERISTICHE GENERALI

Diametri	ø 4 - 5 - 6 - 8 - 10 - 12 - 14 - 16 mm mod. Micro: ø 3 - 4 - 6 - 8 - 10 mm
Filettature	GAS conico ISO 7 (BSPT) GAS cilindrico ISO 228 (BSP); M5-M6 e altri filetti metrici a richiesta; NPT su richiesta mod. Micro: M3 - M5 - M7 - G1/8 - G1/4
Temperatura	-20°C ÷ 80°C (vedere caratteristiche tubi impiegati) mod. Micro: -10°C ÷ 80°C (vedere caratteristiche tubi impiegati)
Tubo di collegamento	Poliammide (PA) 6 - 11 - 12, Poliuretano (PU), Polietilene (PE), Poliesteri hytrel
Fluido	aria compressa (per altri tipi di fluidi consultare i nostri tecnici)
Materiali	- modelli standard: corpo e pinza in OT nichelato, O-ring in NBR, guarnizioni filetto in PTFE - NBR - PA - modelli con autoritenuta: corpo e pinza in OT nichelato, otturatore in OT, molla in acciaio INOX, O-Ring in NBR, guarnizioni filetto in PTFE
Pressione d'esercizio	- modelli standard: -0.9 ÷ 16 bar (vedere tubi) - modelli con autoritenuta: 0 ÷ 16 bar

Raccordo con tubo di collegamento

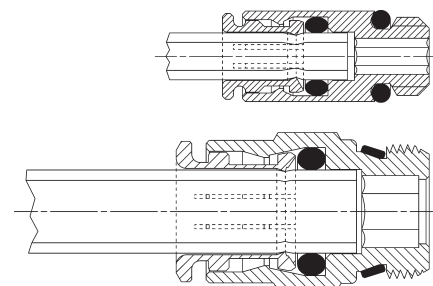

Raccordi Mod. S6510

Diritto Maschio Sprint®



DIMENSIONI										
Mod.	A	D	C	F	G	H	L	SW	SW1	Peso (g)
S6510 4-1/8	4	G1/8	3.8	8.8	13.2	5.5	18	12	2.5	9
S6510 4-1/4	4	G1/4	5.5	8.8	15.2	7	19.5	14	2.5	15
S6510 5-1/8	5	G1/8	3.8	9.8	13.2	5.5	19	12	3	8
S6510 5-1/4	5	G1/4	5.5	9.8	15.2	7	20	14	3	14
S6510 6-1/8	6	G1/8	6	11.7	13.2	5.5	22	12	4	10
S6510 6-1/4	6	G1/4	5.5	11.7	15.2	7	21	14	4	14
S6510 6-3/8	6	G3/8	6.5	11.7	20.5	8	22.5	19	4	27
S6510 8-1/8	8	G1/8	7.5	13.7	15.2	5.5	25	14	5	13
S6510 8-1/4	8	G1/4	6.5	13.7	15.2	7	24	14	6	14
S6510 8-3/8	8	G3/8	6	13.7	20.5	8	23.5	19	6	25
S6510 8-1/2	8	G1/2	7.5	13.7	24.5	9	25	22	6	43
S6510 10-1/4	10	G1/4	8.3	15.4	18.5	7	28.5	17	7	23
S6510 10-3/8	10	G3/8	5.3	15.4	20.5	8	25.5	19	8	27
S6510 10-1/2	10	G1/2	4.8	16	24.5	9	25	22	8	39
S6510 12-1/4	12	G1/4	10.3	18.3	20.5	7	29.5	19	7	26
S6510 12-3/8	12	G3/8	9.3	18.3	20.5	8	28.5	19	9	30
S6510 12-1/2	12	G1/2	5.8	18.3	24.5	9	25	22	10	36
S6510 14-3/8	14	G3/8	10.3	20.5	24.5	8	30.5	22	9	42
S6510 14-1/2	14	G1/2	6.3	20.5	24.5	9	26.5	22	12	34
S6510 16-1/2	16	G1/2	9	23.5	26.5	9	32	24	-	42
S6510 16-3/4	16	G3/4	3.5	23.5	27.3	9	26.5	24	-	46

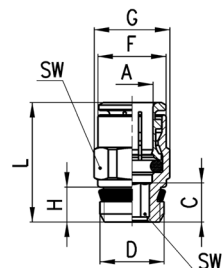

Raccordi Mod. S6510...-LF

Diritto Maschio Sprint® con autoritenuta

Questa versione impedisce il rilascio del flusso d'aria quando viene scollegato il tubo e lo ripristina una volta ricollegato.

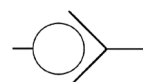
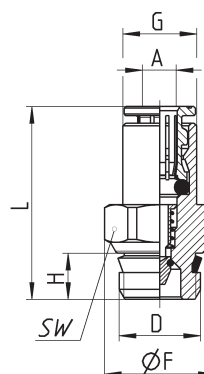

DIMENSIONI								
Mod.	A	D	F	G	H	L	SW	Peso (g)
S6510 4-1/8-LF	4	G1/8	13.2	8.8	5.5	23	12	11
S6510 6-1/8-LF	6	G1/8	13.2	11.7	6	30.5	12	15

Raccordi Mod. 6512 Micro

Diritto Maschio Metrico-Cilindrico

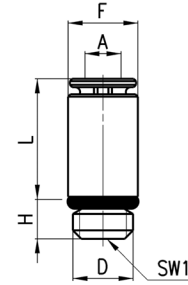

DIMENSIONI							
Mod.	A	D	F	H	L	SW1	Peso (g)
6512 3-M3	3	M3	5.8	2.5	10.2	1.5	1 *
6512 3-M5	3	M5	5.8	3.5	10	2	1 •
6512 4-M7-M	4	M7	9.4	5	17.5	2.5	5 •
6512 4-1/8-M	4	G1/8	11.2	5	13	2.5	9 •, Y
6512 6-M7-M	6	M7	10.4	5	17	4	7 •
6512 6-1/8-M	6	G1/8	11.2	5	14	4	7 •, Y
6512 8-1/8-M	8	G1/8	12.4	5	18.5	5	10 •, Y
6512 10-1/4-M	10	G1/4	14.8	6	21	7	16 •

* = con guarnizione
• = con O-Ring

Raccordi Mod. 6512

Diritto Maschio Metrico-Cilindrico

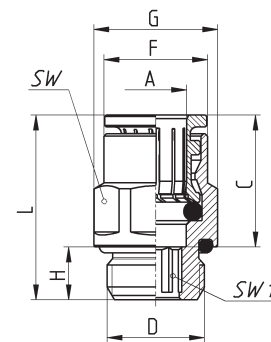

DIMENSIONI										
Mod.	A	D	C	F	G	H	L	SW	SW1	Peso (g)
6512 4-M5	4	M5	14.0	7.8	8.8	4	20	8	2	4
6512 4-M6	4	M6	14.0	8.8	9.9	4.5	20.5	9	2.5	6
6512 4-1/8	4	G1/8	14.0	8.8	13.5	6	19	12	2.5	10
6512 4-1/4	4	G1/4	14.0	8.8	16.4	7	20.5	15	2.5	14
6512 5-M5	5	M5	15.0	8.8	9.9	4	21	9	2	5
6512 6-M5	6	M5	16.0	11.7	13.2	4	22	12	2	8
6512 6-M6	6	M6	16.0	11.7	13.2	4.5	22.5	12	2.5	8
6512 6-1/8	6	G1/8	16.0	11.7	13.5	6	21	12	4	10
6512 6-1/4	6	G1/4	16.0	11.7	16.4	7	22	15	4	13
6512 8-1/8	8	G1/8	17.5	13.7	15.2	6	26	14	5	15
6512 8-1/4	8	G1/4	17.5	13.7	16.4	7	24.5	15	6	17
6512 8-3/8	8	G3/8	17.5	13.7	20.5	7	23	19	6	27
6512 10-1/4	10	G1/4	20.2	15.4	18.5	7	30	17	7	26
6512 10-3/8	10	G3/8	20.2	15.4	20.5	7	24.5	19	8	27
6512 10-1/2	10	G1/2	20.2	15.4	24.8	8	25	22	8	39
6512 12-1/4	12	G1/4	19.2	18.3	20.5	7	29.5	19	7	29
6512 12-3/8	12	G3/8	19.2	18.3	20.5	7	24	19	9	24
6512 12-1/2	12	G1/2	19.2	18.3	24.8	8	24.5	22	9	37
6512 14-3/8	14	G3/8	20.2	20.5	24.5	7	30.5	22	10	38
6512 14-1/2	14	G1/2	20.2	20.5	24.8	8	25.5	22	10	35
6512 16-1/2	16	G1/2	23.0	23.5	26.5	8	33.5	24	-	49

Nuove taglie

Raccordi Mod. 6463

Diritto Femmina Metrico-Cilindrico

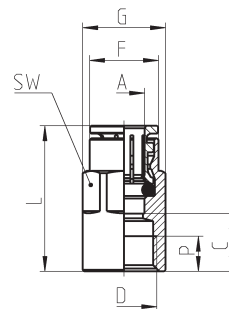

DIMENSIONI									
Mod.	A	D	C	F	G	L	P (min)	SW	Peso (g)
6463 4-M5	4	M5	6.5	7.8	8.8	20.5	4.5	9	8
6463 4-1/8	4	G1/8	10	9	13	24	6	12	14
6463 5-1/8	5	G1/8	10	9.8	13	25	6	12	14
6463 6-1/8	6	G1/8	10	11.7	13	26	6	12	14
6463 6-1/4	6	G1/4	11.5	11.9	16.5	27.5	7	15	23
6463 8-1/8	8	G1/8	9.5	13.7	15.2	27	6	14	16
6463 8-1/4	8	G1/4	11.5	13.7	16.5	29	7	15	23
6463 10-1/4	10	G1/4	11.3	15.4	18.5	31.5	7	17	29

Raccordi Mod. S6520

Gomito Maschio Girevole Sprint®

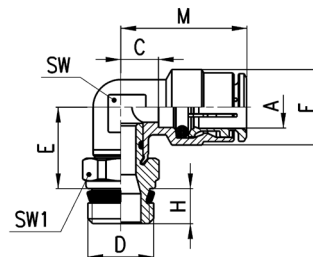

DIMENSIONI										
Mod.	A	D	C	E	F	H	M	SW	SW1	Peso (g)
S6520 4-1/8	4	G1/8	3.5	14.5	9	5.5	17.5	8	12	17
S6520 4-1/4	4	G1/4	3.5	14.5	9	7	17.5	8	14	23
S6520 5-1/8	5	G1/8	5.5	14.5	10	5.5	20.5	9	12	17
S6520 5-1/4	5	G1/4	5.5	14.5	10	7	20.5	9	14	23
S6520 6-1/8	6	G1/8	4	15	12.7	5.5	20	9	12	20
S6520 6-1/4	6	G1/4	4	15	12.7	7	20	9	14	23
S6520 6-3/8	6	G3/8	4	15.5	12.7	8	20	9	19	33
S6520 8-1/8	8	G1/8	5	16	14.2	5.5	22.5	11	12	22
S6520 8-1/4	8	G1/4	5	16	14.2	7	22.5	11	14	26
S6520 8-3/8	8	G3/8	5	16.5	14.2	8	22.5	11	19	41
S6520 8-1/2	8	G1/2	5	17	14.2	9	22.5	11	22	48
S6520 10-1/4	10	G1/4	5.8	18.5	16.5	7	26	13	14	32
S6520 10-3/8	10	G3/8	5.8	19	16.5	8	26	13	19	43
S6520 10-1/2	10	G1/2	5.8	19.5	16.5	9	26	13	22	62
S6520 12-1/4	12	G1/4	7.3	20	19.5	7	26.5	15	17	49
S6520 12-3/8	12	G3/8	7.3	20	19.5	8	26.5	15	19	48
S6520 12-1/2	12	G1/2	7.3	20.5	19.5	9	26.5	15	22	70
S6520 14-3/8	14	G3/8	8.3	21	21.5	8	28.5	17	19	74
S6520 14-1/2	14	G1/2	8.3	21.5	21.5	9	28.5	17	22	78

Raccordi Mod. 6522 Micro



Gomito Maschio Girevole Metrico

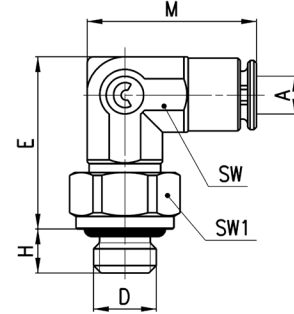

DIMENSIONI									
Mod.	A	D	E	H	M	SW	SW1	Peso (g)	
6522 3-M3	3	M3	13.7	2.5	13.7	6	6	4	*
6522 3-M5	3	M5	13.7	3.5	13.7	6	8	5	•

* = con guarnizione
• = con O-Ring

Raccordi Mod. 6522

Nuove taglie



Gomito Maschio Girevole Metrico-Cilindrico

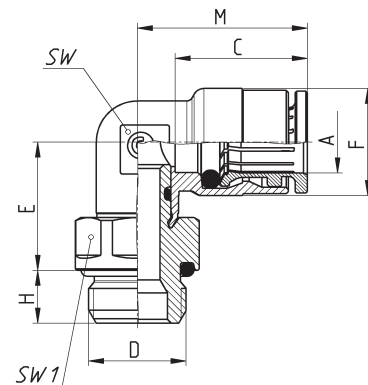

DIMENSIONI										
Mod.	A	D	C	E	F	H	M	SW	SW1	Peso (g)
6522 4-M5	4	M5	14.0	12.5	9	4	17.5	8	8	12
6522 4-1/8	4	G1/8	14.0	14.5	9	6	17.5	8	12	15
6522 4-1/4	4	G1/4	14.0	15.5	9	7	17.5	8	15	25
6522 5-M5	5	M5	15.0	12.5	10	4	20.5	9	8	13
6522 6-M5	6	M5	16.0	13	12.7	4	20	9	10	14
6522 6-1/8	6	G1/8	16.0	15	12.7	6	20	9	12	19
6522 6-1/4	6	G1/4	16.0	16	12.7	7	20	9	15	27
6522 8-1/8	8	G1/8	17.5	16	14.2	6	22.5	11	12	22
6522 8-1/4	8	G1/4	17.5	17	14.2	7	22.5	11	15	28
6522 8-3/8	8	G3/8	17.5	17	14.2	7	22.5	11	19	45
6522 10-1/4	10	G1/4	20.2	19.5	16.5	7	26	13	15	41
6522 10-3/8	10	G3/8	20.2	19.5	16.5	7	26	13	19	45
6522 10-1/2	10	G1/2	20.2	20.5	16.5	8	26	13	22	53
6522 12-1/4	12	G1/4	19.2	20	19.5	7	26.5	15	17	51
6522 12-3/8	12	G3/8	19.2	20.5	19.5	7	26.5	15	19	56
6522 12-1/2	12	G1/2	19.2	21.5	19.5	8	26.5	15	22	58
6522 14-3/8	14	G3/8	20.2	21.5	21.5	7	28.5	17	19	53
6522 14-1/2	14	G1/2	20.2	22.5	21.5	8	28.5	17	22	61

Raccordi Mod. S6500

Gomito Maschio Fisso Metrico

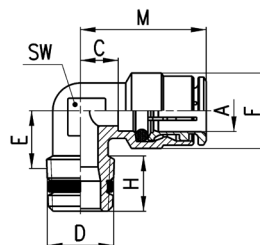

DIMENSIONI										
Mod.	A	D	C	E	F	H	M	SW	Peso (g)	
S6500 4-1/8	4	R1/8	3.5	8.5	9	7.5	17.5	8	9	
S6500 4-1/4	4	R1/4	5	11.5	9	12	19	9	13	
S6500 5-1/8	5	R1/8	5.5	8.5	10	7.5	20.5	9	13	
S6500 5-1/4	5	R1/4	5.5	11.5	10	12	20.5	9	17	
S6500 6-1/8	6	R1/8	4	9	12.7	7.5	20	9	15	
S6500 6-1/4	6	R1/4	4	11.5	12.7	12	20	9	16	
S6500 8-1/8	8	R1/8	5	10.5	14.2	6.5	22.5	11	18	
S6500 8-1/4	8	R1/4	5	11.5	14.2	12.5	22.5	11	21	
S6500 8-3/8	8	R3/8	7	13	14.2	11.5	24.5	12	25	
S6500 10-1/4	10	R1/4	5.8	13	16.5	11.5	26	13	33	
S6500 10-3/8	10	R3/8	5.8	13	16.5	12	26	13	33	
S6500 12-1/4	12	R1/4	7.3	14.5	19.5	11	26.5	15	46	
S6500 12-3/8	12	R3/8	7.3	13.5	19.5	11.5	26.5	15	39	

Raccordi Mod. 6525

Gomito Maschio Girevole Prolungato Sprint®

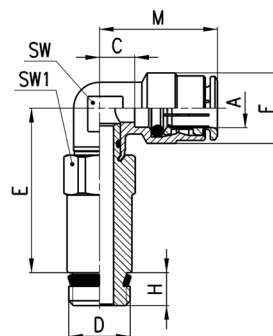

DIMENSIONI										
Mod.	A	D	C	E	F	H	M	SW	SW1	Peso (g)
6525 6-1/8	6	G1/8	4	33.8	12.7	5.5	20	9	12	34
6525 6-1/4	6	G1/4	4	34	12.7	7	20	9	14	47
6525 8-1/8	8	G1/8	5	34.8	14.2	5.5	22.5	11	12	35
6525 8-1/4	8	G1/4	5	35	14.2	7	22.5	11	14	50

Raccordi Mod. 6621 Micro



Asta Metrica Orientabile
con Anello Singolo

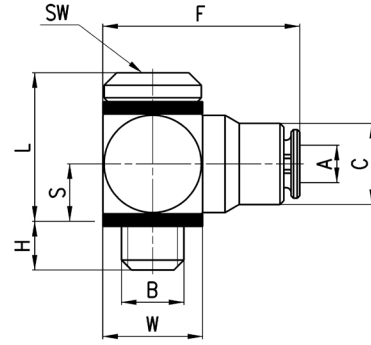

DIMENSIONI										
Mod.	A	B	C	F	H	L	S	W	SW	Peso (g)
6621 3-M3	3	M3	5.8	14.2	2.5	9.3	3.5	6	1.5	5
6621 3-M5	3	M5	6.5	16	3.2	11.9	4.8	8	2	6

Raccordo Mod. 6501 4-M5



Gomito Maschio Fisso Metrico

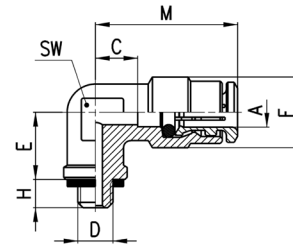

DIMENSIONI									
Mod.	A	D	C	E	F	H	M	SW	Peso (g)
6501 4-M5	4	M5	3.5	6	9	4	17.5	8	11

Raccordi Mod. S6430

T Maschio Girevole Sprint®

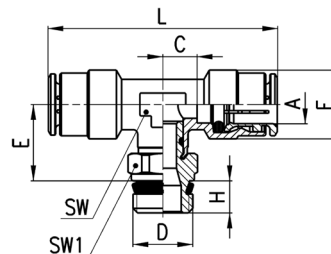

DIMENSIONI										
Mod.	A	D	C	E	F	H	L	SW	SW1	Peso (g)
S6430 4-1/8	4	G1/8	3.5	14.5	9	5.5	35	8	12	18
S6430 5-1/8	5	G1/8	5.5	14.5	10	5.5	41	9	12	24
S6430 5-1/4	5	G1/4	5.5	14.5	10	7	41	9	14	30
S6430 6-1/8	6	G1/8	4	15	12.7	5.5	40	9	12	28
S6430 6-1/4	6	G1/4	4	15	12.7	7	40	9	14	33
S6430 8-1/8	8	G1/8	5	16	14.2	5.5	45	11	12	37
S6430 8-1/4	8	G1/4	5	16	14.2	7	45	11	14	42
S6430 8-3/8	8	G3/8	5	16.5	14.2	8	45	11	19	51
S6430 10-1/4	10	G1/4	5.8	18.5	16.5	7	52	13	14	56
S6430 10-3/8	10	G3/8	5.8	19	16.5	8	52	13	19	67
S6430 10-1/2	10	G1/2	5.8	19.5	16.5	9	52	13	22	85
S6430 12-1/4	12	G1/4	7.3	20	19.5	7	53	15	17	60
S6430 12-3/8	12	G3/8	7.3	20	19.5	8	53	15	19	65
S6430 12-1/2	12	G1/2	7.3	20.5	19.5	9	53	15	22	89
S6430 14-1/2	14	G1/2	8.3	21.5	21.5	9	57	17	22	88

Raccordi Mod. 6432 Micro

T Maschio Girevole Metrico

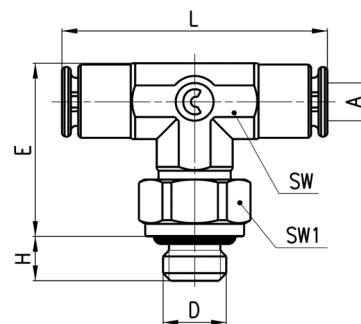

DIMENSIONI								
Mod.	A	D	E	H	L	SW	SW1	Peso (g)
6432 3-M3	3	M3	13.7	2.5	21.4	6	6	5 *
6432 3-M5	3	M5	13.7	3.5	21.4	6	8	6 •

* = con guarnizione
• = con O-Ring

Raccordi Mod. 6432

T Maschio Girevole Metrico-Cilindrico

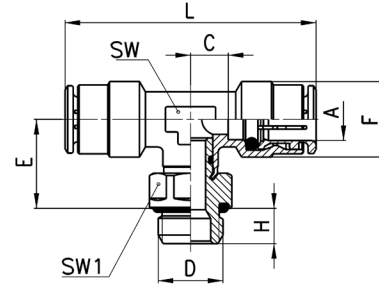

DIMENSIONI										
Mod.	A	D	C	E	F	H	L	SW	SW1	Peso (g)
6432 4-M5	4	M5	3.5	12.5	9	4	35	8	8	14
6432 4-1/8	4	G1/8	3.5	14.5	9	6	35	8	12	19
6432 5-M5	5	M5	5.5	12.5	10	4	41	9	8	19
6432 6-1/8	6	G1/8	4	15	12.7	6	40	9	12	29
6432 6-1/4	6	G1/4	4	16	12.7	7	40	9	15	30
6432 8-1/8	8	G1/8	5	16	14.2	6	45	11	12	37
6432 8-1/4	8	G1/4	5	17	14.2	7	45	11	15	39
6432 8-3/8	8	G3/8	5	17	14.2	7	45	11	19	55
6432 10-1/4	10	G1/4	5.8	19.5	16.5	7	52	13	15	59
6432 10-3/8	10	G3/8	5.8	19.5	16.5	7	52	13	19	56
6432 12-1/4	12	G1/4	7.3	20	19.5	7	53	15	17	60
6432 12-3/8	12	G3/8	7.3	20.5	19.5	7	53	15	19	80

Raccordi Mod. S6440

T Maschio Girevole Laterale Sprint®

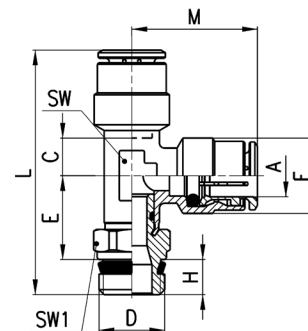

DIMENSIONI											
Mod.	A	D	C	E	F	H	L	M	SW	SW1	Peso (g)
S6440 4-1/8	4	G1/8	3.5	14.5	9	5.5	37.5	17.5	8	12	23
S6440 5-1/8	5	G1/8	5.5	14.5	10	5.5	40.5	20.5	9	12	24
S6440 6-1/8	6	G1/8	4	15	12.7	5.5	40.5	20	9	12	26
S6440 6-1/4	6	G1/4	4	15	12.7	7	42	20	9	14	31
S6440 8-1/8	8	G1/8	5	16	14.2	5.5	44	22.5	11	12	37
S6440 8-1/4	8	G1/4	5	16	14.2	7	45.5	22.5	11	14	35
S6440 8-3/8	8	G3/8	5	16.5	14.2	8	47	22.5	11	19	52
S6440 10-1/4	10	G1/4	5.8	18.5	16.5	7	51.5	26	13	14	43
S6440 10-3/8	10	G3/8	5.8	18.5	16.5	8	53	26	13	19	66
S6440 12-3/8	12	G3/8	7.3	19.5	19.5	8	54.5	26.5	15	19	65
S6440 14-1/2	14	G1/2	8.3	21.5	21.5	9	59	28.5	17	22	88

Raccordi Mod. 6442 Micro



T Maschio Girevole
Laterale Metrico

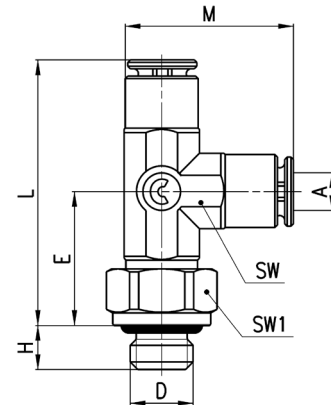

DIMENSIONI										
Mod.	A	D	E	H	L	M	SW	SW1	Peso (g)	
6442 3-M3	3	M3	10.7	2.5	21.4	13.7	6	6	5	*
6442 3-M5	3	M5	12.2	3.5	21.4	13.7	6	8	6	●

* = con guarnizione
● = con O-Ring

Raccordi Mod. 6442



T Maschio Girevole
Laterale Metrico-Cilindrico

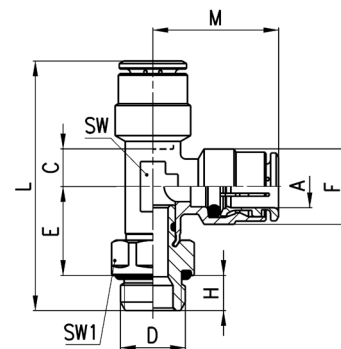

DIMENSIONI											
Mod.	A	D	C	E	F	H	L	M	SW	SW1	Peso (g)
6442 4-M5	4	M5	3.5	12.5	9	4	34	17.5	8	8	18
6442 4-1/8	4	G1/8	3.5	14.5	9	6	38	17.5	8	12	19
6442 5-M5	5	M5	5.5	12.5	10	4	36.5	20.5	9	8	19
6442 6-1/8	6	G1/8	4	15	12.7	6	41	20	9	12	26
6442 6-1/4	6	G1/4	4	16	12.7	7	43	20	9	15	36
6442 8-1/8	8	G1/8	5	16	14.2	6	44.5	22.5	11	12	31
6442 8-1/4	8	G1/4	5	17	14.2	7	46.5	22.5	11	15	42
6442 8-3/8	8	G3/8	5	17	14.2	7	46.5	22.5	11	19	50
6442 10-1/4	10	G1/4	5.8	19.5	16.5	7	52.5	26	13	15	46
6442 10-3/8	10	G3/8	5.8	19.5	16.5	7	52.5	26	13	19	66
6442 12-1/4	12	G1/4	7.3	20	16.5	7	53.5	26.5	15	17	73
6442 12-3/8	12	G3/8	7.3	20.5	16.5	7	54	26.5	15	19	64

Raccordi Mod. 6452 Micro



Y Maschio Girevole Metrico

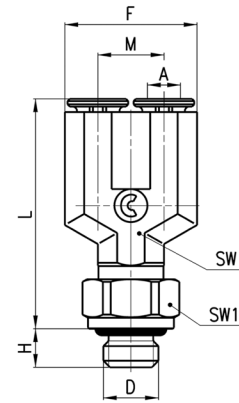

DIMENSIONI										
Mod.	A	D	F	H	L	M	SW	SW1	Peso (g)	
6452 3-M3	3	M3	12	2.5	20.9	6	6	6	6	*
6452 3-M5	3	M5	12	3.5	20.9	6	6	8	7	•

* = con guarnizione
• = con O-Ring

Raccordi Mod. 6451 e Mod. S6450



Mod. 6451: Y Maschio Orientabile Metrico

Mod. S6450: Y Maschio Girevole Sprint®

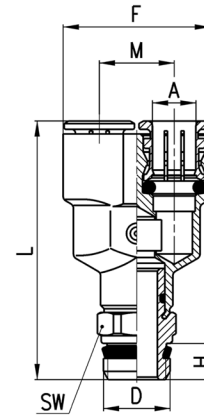

DIMENSIONI									
Mod.	A	D	F	H	L	M	SW	Peso (g)	
6451 4-M5	4	M5	18	4	26.5	9	-	17	*
6451 6-M5	6	M5	24.5	4	29.5	12.5	-	27	*
S6450 4-1/8	4	G1/8	18	5.5	38	9	12	23	
S6450 6-1/8	6	G1/8	24.5	5.5	41.5	12.5	12	33	
S6450 8-1/8	8	G1/8	28.5	5.5	48.5	14.5	14	48	
S6450 8-1/4	8	G1/4	28.5	7	50	14.5	14	50	

* = modello non girevole con guarnizione

Raccordi Mod. 6622



Asta Cilindrica Girevole con Anello Singolo

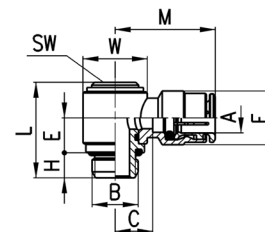

DIMENSIONI											
Mod.	A	B	C	E	F	H	L	M	SW	W	Peso (g)
6622 4-M5	4	M5	4	5.7	8.8	4	15.8	18	2.5	Ø 8	10 *
6622 4-1/8	4	G1/8	7.5	10.2	9	5	25	21.5	4	Ø 14	22
6622 6-1/8	6	G1/8	8	10.2	12.7	5	25	24	4	Ø 14	24
6622 6-1/4	6	G1/4	10	9.1	12.7	6	25.3	26	5	Ø 18	35
6622 8-1/8	8	G1/8	8	10.2	14.2	5	25	25.5	4	Ø 14	28
6622 8-1/4	8	G1/4	10	9.1	14.2	6	25.3	27.5	5	Ø 18	39
6622 10-1/4	10	G1/4	8.8	9.1	16.5	6	25.3	29	5	Ø 18	42

* = Asta Metrica Girevole con Anello Singolo

Raccordi Mod. 6632

Asta Cilindrica Girevole
con Anello Doppio

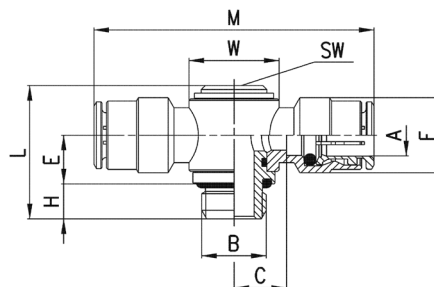

DIMENSIONI											
Mod.	A	B	C	E	F	H	L	M	W	SW	Peso (g)
6632 4-1/8	4	G1/8	7.5	10.2	9	5	25	43	∅ 14	4	24
6632 6-1/8	6	G1/8	8	10.2	12.7	5	25	48	∅ 14	4	33
6632 6-1/4	6	G1/4	10	9.1	12.7	6	25.3	52	∅ 18	5	35
6632 8-1/8	8	G1/8	8	10.2	14.2	5	25	51	∅ 14	4	39
6632 8-1/4	8	G1/4	10	9.1	14.2	6	25.3	55	∅ 18	5	40
6632 10-1/4	10	G1/4	8.8	9.1	16.5	6	25.3	58	∅ 18	5	50

Raccordi Mod. 6620

Anello doppio

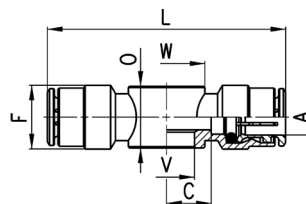

DIMENSIONI									
Mod.	A	C	F	L	O	V	W	Peso (g)	assemblabile con Mod.
6620 4-M5	4	5	9	38	9	5.1	∅ 9	13	SCU, SVU, SCO...
6620 4-1/8	4	7.5	9	43	14.5	9.8	∅ 14	19	1631, 1635, SCU, SVU, SCO...
6620 6-1/8	6	8	12.7	48	14.5	9.8	∅ 14	24	1631, 1635, SCU, SVU, SCO...
6620 6-1/4	6	10	12.7	52	14.5	13.2	∅ 18	26	1631, 1635, SCU, SVU, SCO...
6620 8-1/8	8	8	14.2	51	14.5	9.8	∅ 14	32	1631, 1635, SCU, SVU, SCO...
6620 8-1/4	8	10	14.2	55	14.5	13.2	∅ 18	34	1631, 1635, SCU, SVU, SCO...

Raccordi Mod. 1631 completi di guarnizioni

01... = Vite Cava Singola
02... = Vite Cava Doppia
03... = Vite Cava Tripla



Mod.
1631 01-
1631 02-
1631 03-

Disegni e quote a pagina 2.05.09

Raccordi Mod. 6610

Anello Singolo

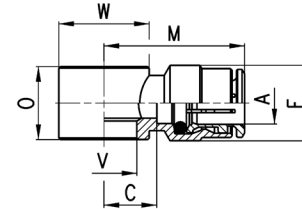

DIMENSIONI									
Mod.	A	C	F	M	O	V	W	Peso (g)	assemblabile con Mod.
6610 4-M5	4	5	9	19	9	5.1	9	9	1631
6610 4-M6	4	5	9	19	9	5.1	9	8	SCU, SVU, SCO...
6610 4-1/8	4	7.5	9	21.5	14.5	9.8	∅ 14	14	1631, 1635, SCU, SVU, SCO...
6610 5-M5	5	5	10	20	9	5.1	9	9	1631
6610 5-M6	5	5	10	20	9	5.1	9	8	SCU, SVU, SCO...
6610 5-1/8	5	8	10	23	14.5	9.8	∅ 14	16	1631, 1635, SCU, SVU, SCO...
6610 6-M5	6	6.5	12.7	22.5	9	5.1	∅ 10	12	1631
6610 6-M6	6	6.5	12.7	22.5	9	5.1	∅ 10	12	SCU, SVU, SCO...
6610 6-1/8	6	8	12.7	24	14.5	9.8	∅ 14	16	1631, 1635, SCU, SVU, SCO...
6610 6-1/4	6	10	12.7	26	14.5	13.2	∅ 18	19	1631, 1635, SCU, SVU, SCO...
6610 8-1/8	8	8	14.2	25.5	14.5	9.8	∅ 14	19	1631, 1635, SCU, SVU, SCO...
6610 8-1/4	8	10	14.2	27.5	14.5	13.2	∅ 18	22	1631, 1635, SCU, SVU, SCO...
6610 8-3/8	8	11	14.2	28.5	14.5	16.7	∅ 21	23	1631, 1635, SCU, SVU, SCO...
6610 10-1/4	10	8.8	16.5	29	14.5	13.2	∅ 18	22	1635, SCU, SVU, SCO...
6610 10-3/8	10	10.3	16.5	30.5	14.5	16.7	∅ 21	23	1635, SCU, SVU, SCO...
6610 12-1/2	12	12.8	16.5	32	14.5	21	∅ 26	37	1635

Raccordi Mod. 6811

Adattatore Maschio Metrico Sprint®

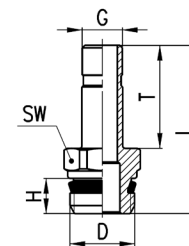

DIMENSIONI							
Mod.	G	D	H	T	L	SW	Peso (g)
6811 4-M5	4	M5	4	16.5	24.5	8	3 *
6811 4-1/8	4	G1/8	5.5	16.5	27.8	12	10
6811 5-1/8	5	G1/8	5.5	18	29.3	12	9
6811 5-1/4	5	G1/4	7	18	31	14	11
6811 6-1/8	6	G1/8	5.5	18	29.3	12	10
6811 6-1/4	6	G1/4	7	18	31	14	12
6811 8-1/8	8	G1/8	5.5	20.5	31.8	12	12
6811 8-1/4	8	G1/4	7	20.5	33.5	14	13
6811 10-1/4	10	G1/4	7	23	36	14	16
6811 10-3/8	10	G3/8	8	23	37.3	19	25
6811 12-3/8	12	G3/8	8	24	38.3	19	25
6811 14-1/2	14	G1/2	9	28	44	22	39

* = con O-Ring

Raccordi S6110



Gomito 45° Maschio Girevole Sprint®

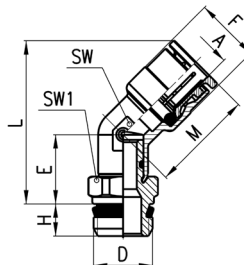

DIMENSIONI											
Mod.	A	D	E	F	H	L	M	SW	SW1	Peso (g)	
S6110 6-1/8	6	G1/8	14	12.7	5.5	32.5	20.5	11	12	21	
S6110 6-1/4	6	G1/4	14	12.7	7	34.5	20.5	11	14	25	
S6110 8-1/8	8	G1/8	14	14.2	5.5	32.5	22.5	11	12	21	
S6110 8-1/4	8	G1/4	14	14.2	7	34.5	22.5	11	14	26	
S6110 8-3/8	8	G3/8	14.5	14.2	8	35	22.5	11	19	38	
S6110 10-1/4	10	G1/4	15.5	16.5	7	39.5	26.5	15	17	39	
S6110 10-3/8	10	G3/8	15.5	16.5	8	39.5	26.5	15	19	44	
S6110 10-1/2	10	G1/2	16	16.5	9	40	26.5	15	22	57	
S6110 12-1/4	12	G1/4	15.5	19.5	7	40.5	26.5	15	17	41	
S6110 12-3/8	12	G3/8	15.5	19.5	8	40.5	26.5	15	19	46	
S6110 12-1/2	12	G1/2	16	19.5	9	41	26.5	15	22	59	

Raccordi Mod. 6590 Micro

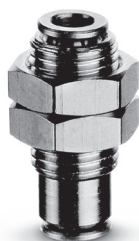

Passaparete

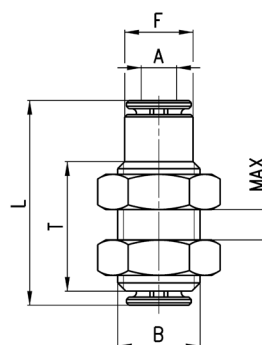

DIMENSIONI							
Mod.	A	B	F	L	MAX	T	Peso (g)
6590 3	3	M7x0.75	5.8	18.4	5	11.4	4

Raccordi Mod. 6590

Passaparete

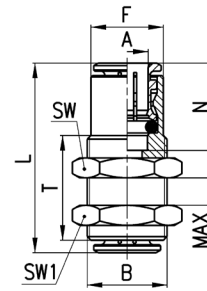

DIMENSIONI										
Mod.	A	B	F	L	N	MAX	SW	SW1	T	Peso (g)
6590 4	4	M10x1	8.8	29	14	10.5	14	14	20	16
6590 5	5	M12x1	9.8	31	15	10.5	17	17	20	25
6590 6	6	M14x1	12.5	33	16	10.5	17	17	20	28
6590 8	8	M16x1	14.5	36	17.5	11.5	19	19	21	35
6590 10	10	M18x1	16.3	41.5	20.2	13	22	22	23.5	51
6590 12	12	M20x1	18.8	39.5	19.2	14.5	24	24	25	56
6590 14	14	M22x1	20.5	41.5	20.2	17.5	27	27	30	82

Raccordo Mod. 6580 Micro

Diritto Intermedio

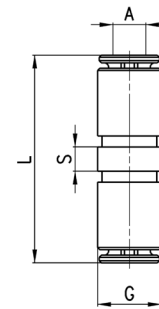

DIMENSIONI					
Mod.	A	G	L	S	Peso (g)
6580 3	3	5.8	19.9	2.2	2

Raccordi Mod. 6580

Diritto Intermedio

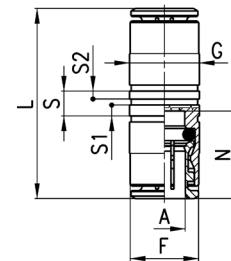

DIMENSIONI									
Mod.	A	F	G	L	N	S	S1	S2	Peso (g)
6580 4	4	8.4	9	29	14	5	2.2	1.6	11
6580 5	5	9.4	10	31	15	5	2.2	1.6	15
6580 6	6	11.7	12	34	16	5	2.2	1.6	16
6580 8	8	13.7	14	37	17.5	5	2.2	1.6	23
6580 10	10	15.4	17	41.5	20.2	5	2.2	1.6	33
6580 12	12	18.3	19	39.5	19.2	5.2	2.2	1.6	40
6580 14	14	20.5	21	41.5	20.2	5.2	2.2	1.6	47
6580 16	16	-	47	47	23	-	-	-	60

Raccordi Mod. 6580 - Ridotto

Diritto Ridotto Intermedio

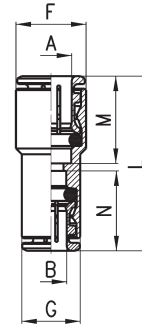

DIMENSIONI									
Mod.	A	B	F	G	L	M	N	Peso (g)	
6580 6-4	6	4	12	9	31.5	16	14	12	
6580 8-6	8	6	14	12.2	35	17.5	16	19	
6580 10-8	10	8	16	14	39	20	17.5	25	
6580 12-10	12	10	19	16	40.5	19	20	35	

Raccordi Mod. 6593

Passaparete Femmina Cilindrica

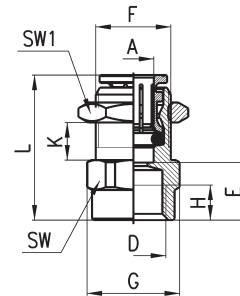

DIMENSIONI												
Mod.	A	D	E	F	G	H	L	K (max)	K (min)	SW	SW1	Peso (g)
6593 6-1/8	6	G1/8	10	M12x1	16.4	6	24.5	8.5	2	15	17	19
6593 6-1/4	6	G1/4	11.5	M12x1	18.5	7	26	6.5	2	17	17	22
6593 8-1/8	8	G1/8	10	M15x1	18.5	6	27	9.5	2	17	19	26
6593 8-1/4	8	G1/4	11.5	M15x1	18.5	7	28.5	9.5	2	17	19	26
6593 10-3/8	10	G3/8	12.8	M18x1	24.5	8	32.5	12	2	22	22	43

Raccordo Mod. 6550 Micro

Gomito Intermedio

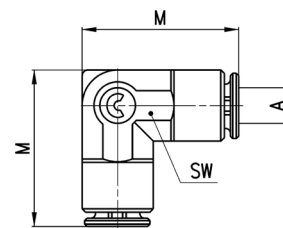

DIMENSIONI				
Mod.	A	M	SW	Peso (g)
6550 3	3	13.7	6	3

Raccordi Mod. 6550

Gomito Intermedio

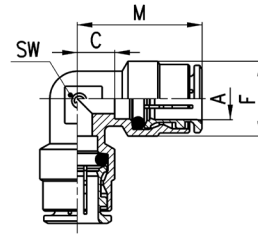

DIMENSIONI						
Mod.	A	C	F	M	SW	Peso (g)
6550 4	4	3.5	9	17.5	8	8
6550 5	5	5.5	10	20.5	9	15
6550 6	6	4	12.7	20	9	17
6550 8	8	5	14.2	22.5	11	22
6550 10	10	5.8	16.5	26	13	30
6550 12	12	7.3	19.5	26.5	15	44
6550 14	14	8.3	21.5	28.5	17	71

Raccordo Mod. 6540 Micro

T Intermedio

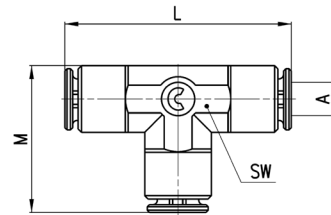

DIMENSIONI					
Mod.	A	L	M	SW	Peso (g)
6540 3	3	21.4	13.7	6	4

Raccordi Mod. 6540

T Intermedio

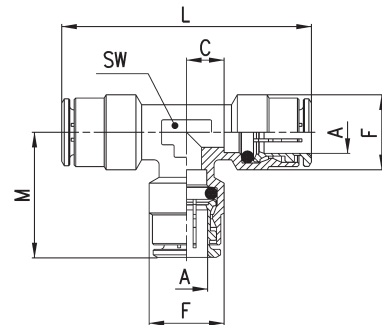

DIMENSIONI							
Mod.	A	C	F	L	M	SW	Peso (g)
6540 4	4	3.5	9	35	17.5	8	14
6540 5	5	5.5	10	41	20.5	9	21
6540 6	6	4	12.7	40	20	9	24
6540 8	8	5	14.2	45	22.5	11	32
6540 10	10	5.8	16.5	52	26	13	43
6540 12	12	7.3	19.5	53	26.5	15	60
6540 14	14	8.3	21.5	57	28.5	17	75

Raccordi Mod. 6600



Intermedio a Croce

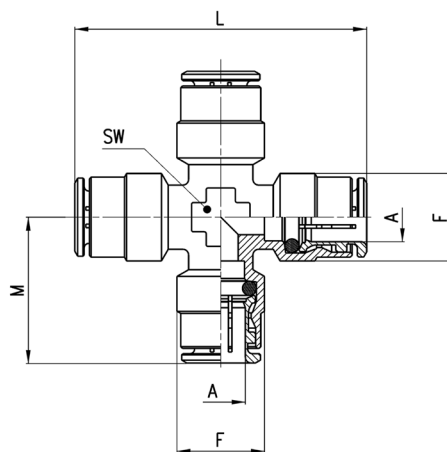

DIMENSIONI						
Mod.	A	F	L	M	SW	Peso (g)
6600 4	4	9	38	19	9	26
6600 5	5	10	41	20.5	9	29
6600 6	6	12.7	44	22	10	35
6600 8	8	14.2	49	24.5	12	50
6600 10	10	16.5	55	27.5	14	63
6600 12	12	19.5	56	28	16	84

Raccordo Mod. 6560 Micro

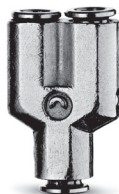

Y Intermedio

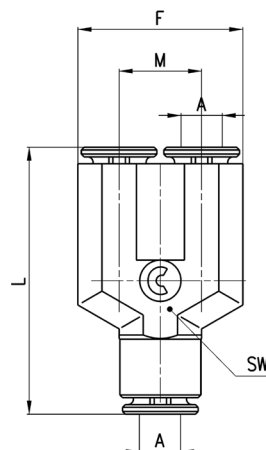

DIMENSIONI						
Mod.	A	F	L	M	SW	Peso (g)
6560 3	3	12	20.4	6	6	5

Raccordi Mod. 6560



Y Intermedio

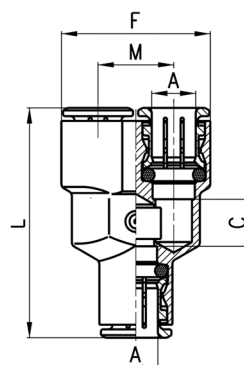

DIMENSIONI						
Mod.	A	C	F	L	M	Peso (g)
6560 4	4	5	18	33	9	19
6560 6	6	7	24.5	39	12.5	30
6560 8	8	9	28.5	44	14.5	42
6560 10	10	15.5	32	53.5	16	63

Raccordi Mod. 6700

Cartuccia



S* = sia per sede metallica
che per sede sintetica

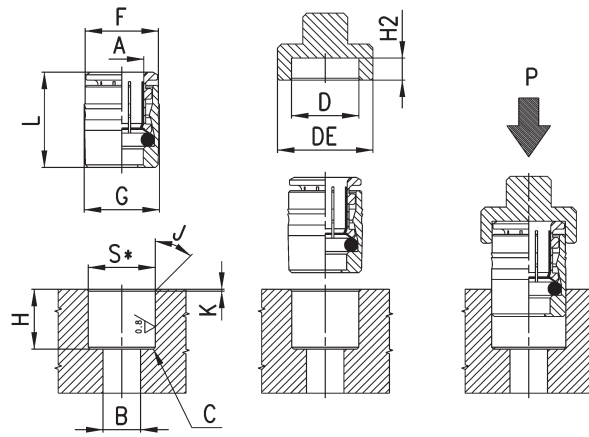

Mod.	A	B	C	D	DE	F	G	H	H2 (+0,1/0)	J	K	L	P min (Kg)	P max (Kg)	S (+0,01/-0,04)	Peso (g)
6700 3	3	2	0.5x45°	6.1	11	5.9	6.2	6.3	2.6	30°	0.3	9.2	80	350	6	1
6700 4	4	3.5	0.5x45°	8.8	14	8.6	9	11	3.3	15°	0.5	14.5	200	360	8.75	4
6700 5	5	3.5	0.5x45°	9.8	15	9.6	10	11.5	3.3	15°	0.5	15.5	230	450	9.75	5
6700 6	6	4	0.5x45°	12	17	11.8	12.2	12	3.8	15°	0.5	16.5	160	570	11.95	8
6700 8	8	6	0.5x45°	14	19	13.8	14.2	14	3.3	15°	0.5	18	140	400	13.95	11
6700 10	10	8	0.5x45°	16	21	15.8	16.2	16.5	3.5	15°	0.5	20.5	150	650	15.95	15

Raccordi Mod. 6750

Tappo femmina

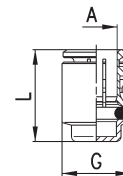

DIMENSIONI				
Mod.	A	G	L	Peso (g)
6750 4	4	8.8	15	4
6750 6	6	11.8	17	7
6750 8	8	13.8	18.5	9
6750 10	10	15.8	21	12
6750 12	12	17.8	20	15

Raccordi Mod. 6850

Maggiorazione

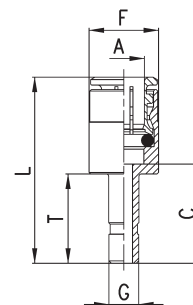

DIMENSIONI							
Mod.	A	G	C	F	L	T	Peso (g)
6850 6-4	6	4	17.5	12.7	33.5	16.5	11
6850 8-6	8	6	19	14	36.5	18	15

Raccordo Mod. 6800 Micro



Riduzione

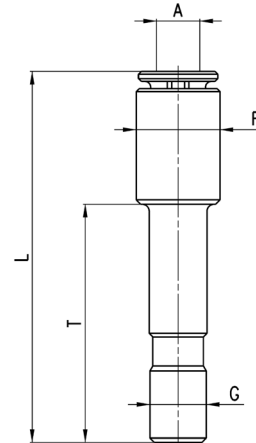

DIMENSIONI						
Mod.	A	F	G	L	T	Peso (g)
6800 3-4	3	5.8	4	26	16.5	2

Raccordi Mod. 6800



Riduzione

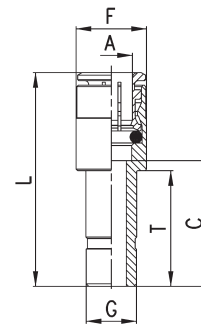

DIMENSIONI							
Mod.	A	G	C	F	L	T	Peso (g)
6800 4-5	4	5	19	9	33	18	8
6800 4-6	4	6	15.5	9	29.5	18	9
6800 4-8	4	8	18	9	32	20.5	10
6800 5-6	5	6	19	10	34	18	11
6800 5-8	5	8	18	10	33	20.5	12
6800 6-8	6	8	18	12.7	34	20.5	12
6800 6-10	6	10	20.5	12.7	36.5	23	17
6800 6-12	6	12	17.5	12.7	33.5	24	21
6800 8-10	8	10	20.5	14	38	23	15
6800 8-12	8	12	21.5	14	39	24	22
6800 10-12	10	12	20.3	16.5	40.5	24	27
6800 10-14	10	14	24.3	16.5	44.5	28	33
6800 12-14	12	14	24.3	18.8	45.5	28	27

Raccordi Mod. 6950



Giunzione

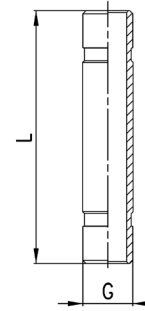

DIMENSIONI			
Mod.	G	L	Peso (g)
6950 4	4	32.5	3
6950 6	6	35.5	4
6950 8	8	40.5	7
6950 10	10	46	10
6950 12	12	48	13
6950 14	14	52	17

Raccordi Mod. 6555



Gomito con Codolo Innestabile

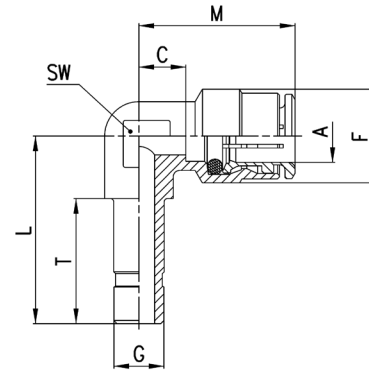

DIMENSIONI									
Mod.	A	G	C	L	F	T	M	SW	Peso (g)
6555 4-4	4	4	3.5	22	9	16.5	17.5	9	8
6555 6-6	6	6	4	24.5	12.7	18	20	9	14
6555 8-8	8	8	5	27.5	14.2	20	22.5	11	21
6555 10-10	10	10	5.8	32	16.5	23	26	13	26

Accessorio Mod. 6708



Cuffie di protezione
Colore: Nero
Materiale autoestinguente Classe V0

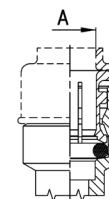
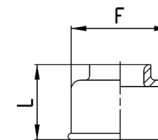

DIMENSIONI				
Mod.	A	F	L	Peso (g)
6708 4	4	10.7	10.7	1
6708 5	5	11.7	11	1
6708 6	6	13.7	11.5	1
6708 8	8	15.7	12.5	1
6708 10	10	18.5	13	1
6708 12	12	20.7	15	2
6708 14	14	23.7	15	2

Accessorio Mod. 6900 Micro



Tappo Maschio in plastica

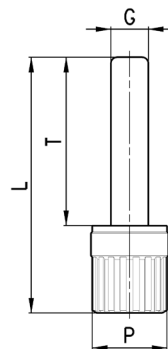

DIMENSIONI					
Mod.	G	L	P	T	Peso (g)
6900 3	3	20.5	6	13.5	1

Accessorio Mod. 6900



Tappo Maschio in plastica

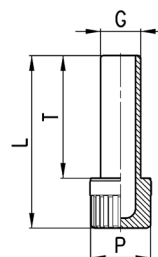

DIMENSIONI					
Mod.	G	L	P	T	Peso (g)
6900 4	4	29	8	20	1
6900 5	5	29.5	8	20.5	1
6900 6	6	31.5	8	22.5	1
6900 8	8	34.5	12	24.5	2
6900 10	10	37	12	27	2
6900 12	12	40.5	16	28.5	3
6900 14	14	42.5	16	30.5	3

Accessorio Mod. SP



Set di chiavi sganciatubo

Il set comprende chiavi per sganciare tubi con Ø da 4 a 12 mm.

Mod.
SP